

# LZ102CT

Sink material	Composite
Type	Composite sink
No. of bowls	1 + 1/2
Drainer	Reversible
EAN code	8017709251697

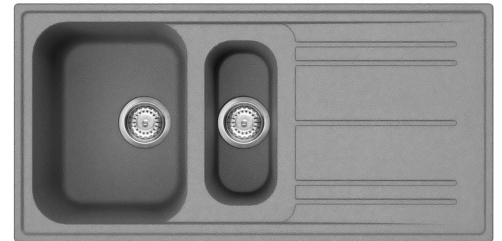

## Aesthetics



<b>Serie</b>	Rigae	<b>Logo</b>	Applied/on overflow
<b>Aesthetic</b>	Universale	<b>Alternative colours available</b>	White, Anthracite, Cream, Beige, Copper
<b>Colour</b>	Cement / Concrete	<b>Half bowl cup drainer</b>	Yes
<b>Building in type</b>	Standard	<b>Tap hole / precut tap hole</b>	Prepared

	Bowl type RH	Bowl dimensions, WxDxH (mm)	Bowl depth (mm)	Radius corner right bowl (mm)	Overflow LH bowl	Strainer position	Strainer dimension
RH Bowl	Half bowl	150 x 340 x 168	168	50		Centre of bowl	3.5"
LH Bowl	Traditional	420 x 320 x 210	210	80	Yes, traditional	Side bowl	3.5"

## Technical Features



<b>Characteristics composite material</b>	Antibacterial, Anti-scratch, Thermal shock resistant, High temperatures resistant, Impact resistant, Easy to clean, UV Resistant	<b>Tap hole</b>	2
<b>Frame depth (mm)</b>	10	<b>Tap hole diameter</b>	35 mm
		<b>Dividing wall width</b>	38 mm
		<b>Drainer inclination</b>	2 °
		<b>No. of clips</b>	10
		<b>Type of clips</b>	Standard

Dimensions of the product (mm)	210x1000x500 mm
Cutout dimension topmount (mm)	980 X 480 mm
Undermount cutout radius	30 mm
Height from kitchen top	10 mm
Base unit size	60 cm

## Accessories Included

Accessories for installation	Strainer, Savespace siphon with dishwasher outlet connection, Fixing clips
------------------------------	--

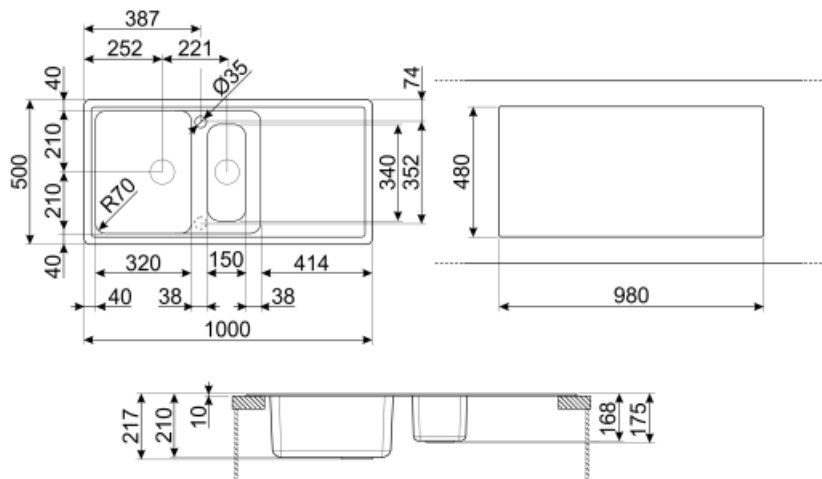

---

## Not included accessories

---



### KITFD050

Waste disposal 0,5 HP, Motor: 1/2 horsepower, Fits all sinks with 3 1/2" waste outlet



### KITDSQ

Soap dispenser chrome finishing with square knob 40x40 mm



### KITFD050UK

Waste disposal 0,5 HP, Motor: 1/2 horsepower, Fits all sinks with 3 1/2" waste outlet, UK



### KITFD100

Waste disposal 1 HP, Motor: 1/2 horsepower, Fits all sinks with 3 1/2" waste outlet



### KITFD075

Waste disposal 0,75 HP, Motor: 1/2 horsepower, Fits all sinks with 3 1/2" waste outlet

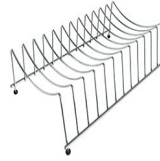













### COLPTX

Draining rack base 300 x 185 x 82 mm

---

## Symbols glossary (TT)

---

	Antibacterial		Antiscratch
	Cupboard width required for sink installation		Sink depth - depending on the model, the depth can be from 13 to 24,5
	Sink depth - depending on the model, the depth can be from 13 to 24,5		Standard installation: Traditional installation in tabletop, suitable for any kitchen sets
	Easy to clean		High temperatures resistant
	Impact resistant		Thanks to the double tap hole, most of our sinks are easily reversible, giving you the flexibility to make any type of kitchen composition.
	Thermal shock resistant		UV protection, does not fade over time.