

# LZ102P

Sink material	Composite
Type	Composite sink
No. of bowls	1 + 1/2
Drainer	Reversible
EAN code	8017709182823



## Aesthetics



<b>Aesthetic</b>	Universale	<b>Logo</b>	Applied/on overflow
<b>Colour</b>	Cream	<b>Alternative colours available</b>	White, Anthracite, Beige, Copper, Cemento / Concrete
<b>Series</b>	Rigae	<b>Tap hole / precut tap hole</b>	Prepared
<b>Building in type</b>	Standard		

	Bowl type RH	Bowl dimensions, WxDxH (mm)	Bowl depth (mm)	Radius corner right bowl (mm)	Overflow LH bowl	Strainer position	Strainer dimension
RH Bowl	Half bowl	150 x 340 x 168	168	50		Centre of bowl	3.5"
LH Bowl	Traditional	420 x 320 x 210	210	80	Yes, traditional	Side bowl	3.5"

## Technical Features



<b>Characteristics composite material</b>	Antibacterial, Easy to clean, Anti-scratch, Thermal shock resistant, High temperatures resistant, Impact resistant, UV Resistant	<b>Tap hole</b>	2
		<b>Tap hole diameter</b>	35 mm
		<b>Dividing wall width</b>	38 mm
		<b>Drainer inclination</b>	2 °
		<b>No. of clips</b>	10
<b>Frame depth (mm)</b>	10	<b>Type of clips</b>	Standard

Dimensions of the product (mm)	210x1000x500 mm	Possibility to install waste disposal	Yes
Cutout dimension topmount (mm)	980 X 480 mm		
Undermount cutout radius	30 mm		
Height from kitchen top	10 mm		
Base unit size	60 cm		

## Accessories included

Accessories for installation	Strainer, Savespace siphon with dishwasher outlet connection, Fixing clips
------------------------------	--

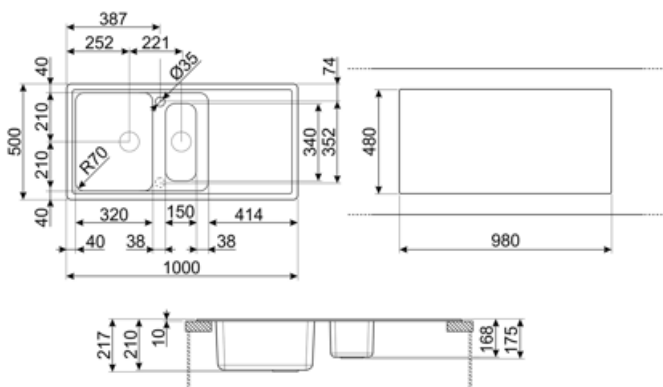

---

## Compatible Accessories

---



### **KITDSQ**

Soap dispenser chrome finishing with square knob 40x40 mm



### **KITFD075**

Waste disposal 0,75 HP, Motor: 1/2 horsepower, Fits all sinks with 3 1/2" waste outlet



### **KITFD050**

Waste disposal 0,5 HP, Motor: 1/2 horsepower, Fits all sinks with 3 1/2" waste outlet



### **KITFD100**

Waste disposal 1 HP, Motor: 1/2 horsepower, Fits all sinks with 3 1/2" waste outlet

---

## Alternative products

---

**LZ102CT**

**Colour: Cement / Concrete**



**LZ102AV2**

**Colour: Oats**



**LZ102A2**

**Colour: Anthracite**















**LZ102B**

**Colour: White**



## Symbols glossary

	Cupboard width required for sink installation.		Sink depth - depending on the model, the depth can be from 13 to 24,5.
	Sink depth - depending on the model, the depth can be from 13 to 24,5.		Standard installation: Traditional installation in tabletop, suitable for any kitchen sets.
	Antibacterial		Antiscratch
	Thermal shock resistant		High temperatures resistant
	Impact resistant		Easy to clean
	Thanks to the double tap hole, most of our sinks are easily reversible, giving you the flexibility to make any type of kitchen composition.		UV protection, does not fade over time.