

LZ102P

Materiale	Composito
Tipologia	Lavello composito
Numero vasche	1 + 1/2
Gocciolatoio	Reversibile
Codice EAN	8017709182823



Estetica



Estetica	Universale	Logo	Applicato/Inciso TP
Colore	Panna	Altri colori disponibili	Bianco, Antracite, Avena, Rame, Cemento / Concrete
Serie	Rigae	Forato / predisposto per foratura	Predisp.
Tipo incasso	Standard		

	Tipologia vasca dx	Dimensioni vasca dx, L x P x A (mm)	Profondità vasca dx (mm)	Raggio angolare vasca dx	Troppopieno vasca sx	Posizione scarico vasca	Dimensione scarico vasca
Vasca dx	Vaschino	150 x 340 x 168	168	50		Centro vasca	3.5"
Vasca sx	Tradizionale	420 x 320 x 210	210	80	Si, tradizionale	Laterale vasca	3.5"

Caratteristiche Tecniche

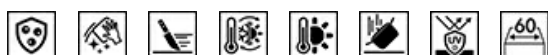

Caratteristiche materiale composito

Antibatterico, Facile da pulire, Antigraffio, Resistente agli shock termici, Resistente alle temperature elevate, Resistente agli urti, Resistente ai raggi UV

Profondità invaso (mm) 10

Foro miscelatore	2
Diametro foro miscelatore	35 mm
Larghezza cavallotto	38 mm
Inclinazione gocciolatoio	2 °
Numero ganci	10
Tipologia ganci	Standard

Dimensioni del prodotto (mm) 210x1000x500 mm

Possibilità di installare il tritarifiuti Sì

Dimensioni foro incasso sopratop (mm) 980 X 480 mm

Raggio angolare foro incasso sottotop 30 mm

Altezza da top cucina 10 mm

Misura mobile incasso 60 cm

Dotazione accessori Inclusi

Dotazione accessori montaggio Piletta, Sifone salvaspazio con attacco lavastoviglie, Ganci montaggio

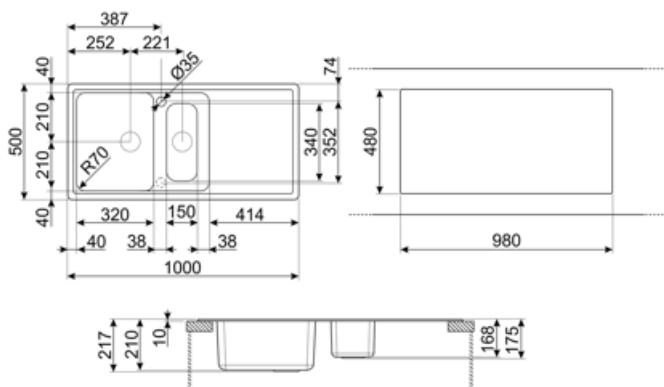

Accessori Compatibili



KITDSQ

Dispenser di sapone finitura cromata con manopola quadrata 40x40 mm



KITFD075

Tritarifiuti 0,75 HP, Motore: 1/2 potenza, Adatto a tutti i lavelli con scarico da 3 1/2 "



KITFD050

Tritarifiuti 0,5 HP, Motore: 1/2 potenza, Adatto a tutti i lavelli con scarico da 3 1/2 "



KITFD100

Tritarifiuti 1 HP, Motore: 1/2 potenza, Adatto a tutti i lavelli con scarico da 3 1/2 "

Prodotti alternativi

LZ102CT

Colore: Cemento



LZ102AV2

Colore: Avena



LZ102A2

Colore: Antracite















LZ102B

Colore: Bianco



Glossario simboli

	Antibatterico		Antigraffio
	Dimensione del mobile base: Dimensione del mobile base necessaria per l'installazione del lavello.		Indica la profondità della vasca.
	Indica la profondità della vasca.		Standard: modalità di installazione, che si abbina facilmente a qualsiasi tipo di cucina.
	Resistente agli shock termici		Resistente alle temperature elevate
	Resistente agli urti		Facile da pulire
	Grazie al doppio foro per miscelatore, la maggior parte dei nostri lavelli è facilmente reversibile, offrendoti la flessibilità necessaria per realizzare qualsiasi tipo di composizione cucina.		Protezione UV, non scolorisce nel tempo.