

# LZ116A2

Materiale	Composito
Tipologia	Lavello composito
Numero vasche	2
Gocciolatoio	Reversibile
Codice EAN	8017709251666



## Estetica



Estetica	Universale	Logo	Applicato/Inciso TP
Colore	Nero	Altri colori disponibili	Bianco, Panna, Avena, Rame, Cemento / Concrete
Serie	Rigae	Forato / predisposto per foratura	Predisp.
Tipo incasso	Standard		

	Tipologia vasca dx	Dimensioni vasca dx, L x P x A (mm)	Profondità vasca dx (mm)	Raggio angolare vasca dx	Troppopieno vasca	Posizione scarico vasca	Dimensione scarico vasca
Vasca dx	Tradizionale	330 x 420 x 210	210	80	Si, tradizionale	Laterale vasca	3.5"
Vasca sx	Tradizionale	330 x 420 x 210	210	80		Laterale vasca	3.5"

## Caratteristiche Tecniche



### Caratteristiche materiale composito

Antibatterico, Facile da pulire, Antigraffio, Resistente agli shock termici, Resistente alle temperature elevate, Resistente agli urti, Resistente ai raggi UV

Profondità invaso (mm) 10

Foro miscelatore	2
Diametro foro miscelatore	35 mm
Larghezza cavallotto	38 mm
Inclinazione gocciolatoio	2°
Numero ganci	12
Tipologia ganci	Standard

---

Dimensioni del prodotto (mm)	210x1160x500 mm
Dimensioni foro incasso sopratop (mm)	1140 X 480 mm
Raggio angolare foro incasso sottotop	30 mm
Altezza da top cucina	10 mm
Misura mobile incasso	80 cm

## Dotazione accessori Inclusi

---

Dotazione accessori montaggio	Piletta, Sifone salvaspazio con attacco lavastoviglie, Ganci montaggio
-------------------------------	--

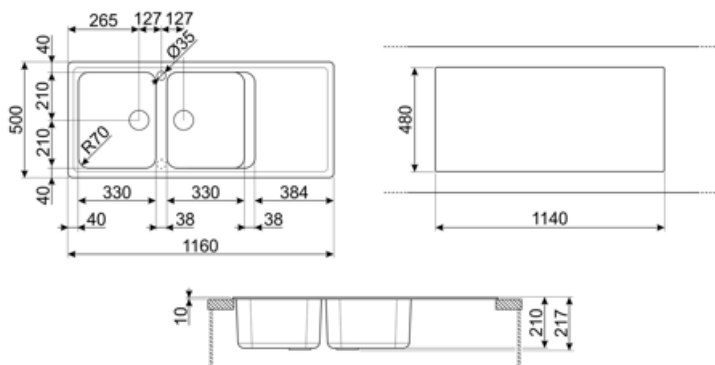

---

## Accessori Compatibili

---



### **KITDSQ**

Dispenser di sapone finitura cromata con manopola quadrata 40x40 mm



### **KITFD075**

Tritarifiuti 0,75 HP, Motore: 1/2 potenza, Adatto a tutti i lavelli con scarico da 3 1/2 "



### **KITFD050**

Tritarifiuti 0,5 HP, Motore: 1/2 potenza, Adatto a tutti i lavelli con scarico da 3 1/2 "



### **KITFD100**

Tritarifiuti 1 HP, Motore: 1/2 potenza, Adatto a tutti i lavelli con scarico da 3 1/2"

---

## Prodotti alternativi

---

**LZ116B**

**Colore: Bianco**



**LZ116AV2**

**Colore: Avena**



**LZ116CT**

**Colore: Cemento**













**LZ116P**

**Colore: Panna**



## Glossario simboli

	Dimensione del mobile base: Dimensione del mobile base necessaria per l'installazione del lavello.		Indica la profondità della vasca.
	Standard: modalità di installazione, che si abbina facilmente a qualsiasi tipo di cucina.		Antibatterico
	Antigraffio		Resistente agli shock termici
	Resistente alle temperature elevate		Resistente agli urti
	Facile da pulire		Grazie al doppio foro per miscelatore, la maggior parte dei nostri lavelli è facilmente reversibile, offrendoti la flessibilità necessaria per realizzare qualsiasi tipo di composizione cucina.
	Protezione UV, non scolorisce nel tempo.		