

LZ150A2

Sink material	Composite
Type	Composite sink
No. of bowls	1
Drainer	Reversible
EAN code	8017709274603



Aesthetics



Aesthetic	Universale	Logo	Applied/on overflow
Series	Rigae	Alternative colours available	White, Cream, Beige, Cemento / Concrete
Colour	Anthracite	Tap hole / precut tap hole	Prepared
Building in type	Standard		

	Bowl type LH	Bowl dimensions LH, WxDxA (mm)	LH Bowl depth (mm)	Radius corner left bowl	Overflow LH bowl	Strainer position LH bowl	Strainer dimension LH bowl
LH Bowl	Traditional	420 x 480 x 210	210	80	Yes, traditional	Side bowl	3.5"

Technical Features



Characteristics composite material	Antibacterial, Easy to clean, Anti-scratch, Thermal shock resistant, High temperatures resistant, Impact resistant, UV Resistant	Base unit size	60 cm
Frame depth (mm)	10	Tap hole	2
Dimensions of the product (mm)	210x1000x500 mm	Tap hole diameter	35 mm
Cutout dimension topmount (mm)	980 X 480 mm	Drainer inclination	2 °
		No. of clips	10
		Type of clips	Standard

Undermount cutout radius 30 mm

Height from kitchen top 10 mm

Accessories Included

Accessories for installation

Strainer, Savespace siphon with dishwasher outlet connection, Fixing clips

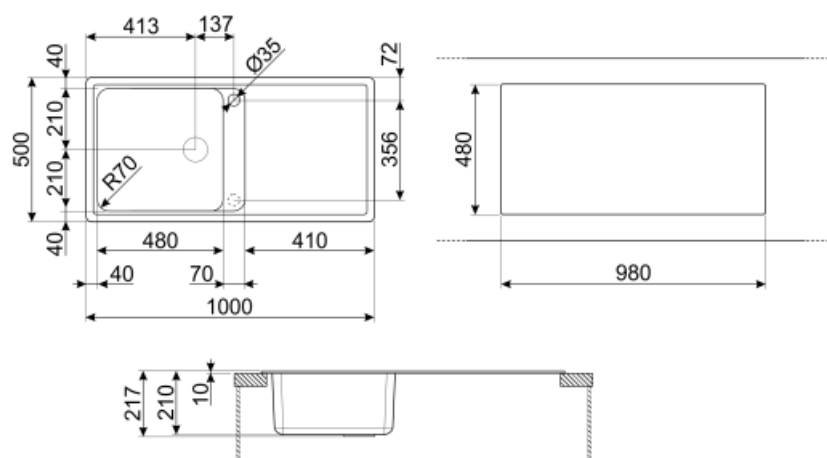

Not included accessories



KITFD050

Waste disposal 0,5 HP, Motor: 1/2 horsepower, Fits all sinks with 3 1/2" waste outlet



KITFD100

Waste disposal 1 HP, Motor: 1/2 horsepower, Fits all sinks with 3 1/2" waste outlet



KITFD075

Waste disposal 0,75 HP, Motor: 1/2 horsepower, Fits all sinks with 3 1/2" waste outlet



COL36











St/steel colander for MINIMUM radius bowls, measures 370 x 410 x 30 mm



KITDSQ

Soap dispenser chrome finishing with square knob 40x40 mm

Symbols glossary (TT)

	Antibacterial		Antiscratch
	Cupboard width required for sink installation		Sink depth - depending on the model, the depth can be from 13 to 24,5
	Standard installation: Traditional installation in tabletop, suitable for any kitchen sets		Easy to clean
	High temperatures resistant		Impact resistant
	Thanks to the double tap hole, most of our sinks are easily reversible, giving you the flexibility to make any type of kitchen composition.		Thermal shock resistant
	UV protection, does not fade over time.		