

LZ150B

Materiale	Composito
Tipologia	Lavello composito
Numero vasche	1
Gocciolatoio	Reversibile
Codice EAN	8017709274610



Estetica



Estetica	Universale	Logo	Applicato/Inciso TP
Colore	Bianco	Altri colori disponibili	Antracite, Panna, Avena, Cemento / Concrete
Serie	Rigae	Forato / predisposto per foratura	Predisp.
Tipo incasso	Standard		

	Tipologia vasca sx	Dimensioni vasca sx, L x P x A (mm)	Profondità vasca sx (mm)	Raggio angolare vasca sx	Trooppieno vasca sx	Posizione scarico vasca sx	Dimensione scarico vasca sx
Vasca sx	Tradizionale	420 x 480 x 210	210	70	Si, tradizionale	Laterale vasca	3.5"

Caratteristiche Tecniche



Caratteristiche materiale composito	Antibatterico, Facile da pulire, Antigraffio, Resistente agli shock termici, Resistente alle temperature elevate, Resistente agli urti, Resistente ai raggi UV	Misura mobile incasso	60 cm
Profondità invaso (mm)	10	Foro miscelatore	2
Dimensioni del prodotto (mm)	210x1000x500 mm	Diametro foro miscelatore	35 mm
		Inclinazione gocciolatoio	2 °
		Numero ganci	10
		Tipologia ganci	Standard

Dimensioni foro incasso 980 X 480 mm
sopratop (mm)

Raggio angolare foro
incasso sottotop 30 mm

Altezza da top cucina 10 mm

Dotazione accessori Inclusi

Dotazione accessori
montaggio Piletta, Sifone salvaspazio
con attacco lavastoviglie,
Ganci montaggio

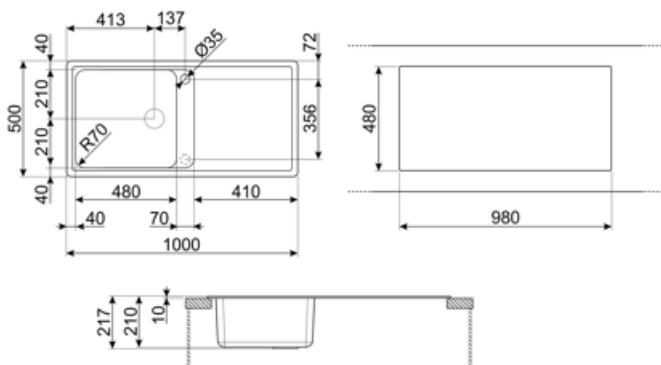

Accessori Compatibili



COL36

Scolapasta in acciaio per vasca raggio MINIMO, misure 370 x 410 x 30 mm



KITFD050

Tritarifiuti 0,5 HP, Motore: 1/2 potenza, Adatto a tutti i lavelli con scarico da 3 1/2 "



KITFD100

Tritarifiuti 1 HP, Motore: 1/2 potenza, Adatto a tutti i lavelli con scarico da 3 1/2 "



KITDSQ

Dispenser di sapone finitura cromata con manopola quadrata 40x40 mm



KITFD075

Tritarifiuti 0,75 HP, Motore: 1/2 potenza, Adatto a tutti i lavelli con scarico da 3 1/2 "

Prodotti alternativi

LZ150CT

Colore: Cemento



LZ150AV2

Colore: Avena



LZ150P

Colore: Panna













LZ150A2

Colore: Antracite



Glossario simboli

	Dimensione del mobile base: Dimensione del mobile base necessaria per l'installazione del lavello.		Indica la profondità della vasca.
	Standard: modalità di installazione, che si abbina facilmente a qualsiasi tipo di cucina.		Antibatterico
	Antigraffio		Resistente agli shock termici
	Resistente alle temperature elevate		Resistente agli urti
	Facile da pulire		Grazie al doppio foro per miscelatore, la maggior parte dei nostri lavelli è facilmente reversibile, offrendoti la flessibilità necessaria per realizzare qualsiasi tipo di composizione cucina.
	Protezione UV, non scolorisce nel tempo.		