

LZ150CT

Sink material	Composite
Type	Synthetic sink
No. of bowls	1
Drainer	Reversible
EAN code	8017709274627

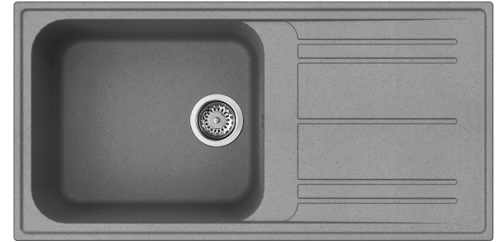

Aesthetics



Aesthetic	Universal	Logo	Applied/on overflow
Serie	Rigae	Alternative colours available	White, Anthracite, Cream, Beige
Colour	Cement / Concrete	Half bowl cup drainer	No
Building in type	Standard	Tap hole / precut tap hole	Prepared

	Bowl type LH	Bowl dimensions LH, WxDxA (mm)	LH Bowl depth (mm)	Radius corner left bowl	Overflow LH bowl	Strainer position LH bowl	Strainer dimension LH bowl
LH Bowl	Traditional	420 x 480 x 210	210	80	Yes, traditional	Side bowl	3.5"

Technical Features



Características do material composto

Válvula de escoamento, Fácil de limpar, Sifão com ligação à máquina de lavar louça, Resistente a choques térmicos, Ganchos de fixação, Vedantes, Resistente a UV

Frame depth (mm)

10

Dimensions of the product (mm)

210x1000x500 mm

Tap hole

2

Diâmetro do furo da torneira

35 mm

Popup command

No

Drainer inclination

2 °

Pre-assembled gasket

No

No. of clips

10

Type of clips

Standard

Cutout dimension topmount (mm)	980 X 480 mm
Cutout radius	30 mm
Height from kitchen top	10 mm
Base unit size	60 cm

Accessories Included

Accessories for installation	Strainer, Siphon with dishwasher outlet connection, Fixing clips	Basket	No
		Wooden board	No
		White board	No
Colander	No		
Rondò Cover waste kit	No		
Glass board	No		

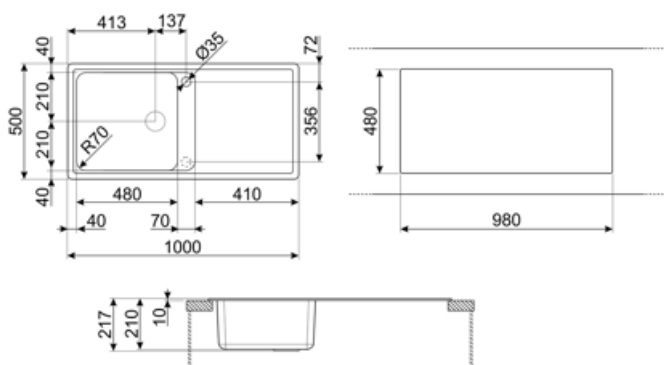

Compatible Accessories



COL36

Coador de aço para tigelas de raio mínimo, mede 370 x 410 x 30 mm



KITFD050

Eliminação de resíduos 0,5 CV Motor: 1/2 cv Serve para todas as pias com saída de resíduos de 3 1/2"



KITFD100

Eliminação de resíduos 1 CV Motor: 1 cv Serve para todas as pias com saída de resíduos de 3 1/2"



KITDSQ











Botão quadrado do dispensador de sabão



KITFD075

Eliminação de resíduos 0,75 CV Motor: 3/4 CV Adapta-se a todas as pias com saída de resíduos de 3 1/2"

Symbols glossary

	Antisséptico		Antirrisco
	Largura do armário necessária para a instalação da pia		Profundidade da pia - dependendo do modelo, a profundidade pode ser de 13 a 24,5
	Instalação padrão: Instalação tradicional em tampo de mesa, adequado para qualquer conjunto de cozinha		Fácil de limpar
	Resistente a choques térmicos		Resistente a altas temperaturas
	Resistente a impactos		Graças ao furo duplo para torneira, a maioria de nossas pias são facilmente reversíveis, dando-lhe a flexibilidade de fazer qualquer tipo de composição de cozinha.
	A proteção UV, não se desvanece com o tempo.		

Benefit (TT)

One bowl

A single bowl for greater adaptability, capacity and space optimisation

Drainer

The drawer allows dishes, cutlery and kitchen utensils to be placed directly on the sink after washing: excess water can drain into the sink, allowing for natural drying

Double tap hole

The sink is easily reversible, making it possible to create any type of kitchen composition

Tap hole possibility

Possibility of having the tap hole for direct installation of the tap on the sink, for a larger and neater surface area