

LZ861A2

Materiale	Composito
Tipologia	Lavello composito
Numero vasche	1
Gocciolatoio	Reversibile
Codice EAN	8017709251727



Estetica



Serie	Rigae	Logo	Applicato/Inciso TP
Estetica	Universale	Altri colori disponibili	Bianco, Panna, Avena, Rame, Cemento / Concrete
Colore	Antracite	Forato / predisposto per foratura	Predisp.
Tipo incasso	Standard		

	Tipologia vasca sx	Dimensioni vasca sx, L x P x A (mm)	Profondità vasca sx (mm)	Raggio angolare vasca sx	Trooppieno vasca sx	Posizione scarico vasca sx	Dimensione scarico vasca sx
Vasca sx	Tradizionale	330 x 420 x 210	210	80	Si, tradizionale	Laterale vasca	3.5"

Caratteristiche Tecniche



Caratteristiche materiale composito	Antibatterico, Antigraffio, Resistente agli shock termici, Resistente alle temperature elevate, Resistente agli urti, Facile da pulire, Resistente ai raggi UV	Misura mobile incasso	45 cm
Profondità invaso (mm)	10	Foro miscelatore	2
Dimensioni del prodotto (mm)	210x860x500 mm	Diametro foro miscelatore	35 mm
		Inclinazione gocciolatoio	2 °
		Numero ganci	8
		Tipologia ganci	Standard

Dimensioni foro incasso 840 X 480 mm
sopratop (mm)
Raggio angolare foro 30 mm
incasso sottotop
Altezza da top cucina 10 mm

Dotazione Accessori Inclusi

Dotazione accessori
montaggio Piletta, Sifone salvaspazio
con attacco lavastoviglie,
Ganci montaggio

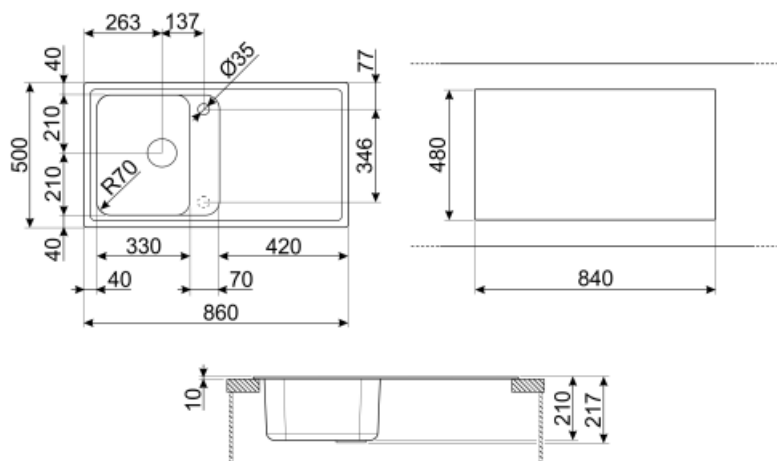

Accessori non inclusi



KITFD050

Tritarifiuti 0,5 HP, Motore: 1/2 potenza,
Adatto a tutti i lavelli con scarico da 3
1/2 "



KITDSQ

Dispenser di sapone finitura cromata
con manopola quadrata 40x40 mm



KITFD050UK

Tritarifiuti 0,5 HP, Motore: 1/2 potenza,
Adatto a tutti i lavelli con scarico da 3
1/2 ", UK



KITFD100

Tritarifiuti 1 HP, Motore: 1/2 potenza,
Adatto a tutti i lavelli con scarico da 3
1/2"



KITFD075



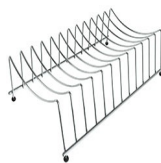







Tritarifiuti 0,75 HP, Motore: 1/2
potenza, Adatto a tutti i lavelli con
scarico da 3 1/2 "



COLPTX

Base scolapiatti 300 x 185 x 82 mm

Glossario simboli

	Antibatterico		Antigraffio
	Dimensione del mobile base: Dimensione del mobile base necessaria per l'installazione del lavello.		Indica la profondità della vasca.
	Standard: modalità di installazione, che si abbina facilmente a qualsiasi tipo di cucina.		Facile da pulire
	Resistente alle temperature elevate		Resistente agli urti
	Grazie al doppio foro per miscelatore, la maggior parte dei nostri lavelli è facilmente reversibile, offrendoti la flessibilità necessaria per realizzare qualsiasi tipo di composizione cucina.		Resistente agli shock termici
	Protezione UV, non scolorisce nel tempo.		