

# LZ861P

Sink material	Composite
Type	Composite sink
No. of bowls	1
Drainer	Reversible
EAN code	8017709183172



## Aesthetics



<b>Aesthetic</b>	Universale	<b>Logo</b>	Applied/on overflow
<b>Colour</b>	Cream	<b>Alternative colours available</b>	White, Anthracite, Beige, Copper, Cemento / Concrete
<b>Series</b>	Rigae	<b>Tap hole / precut tap hole</b>	Prepared
<b>Building in type</b>	Standard		

	Bowl type LH	Bowl dimensions LH, WxDxA (mm)	LH Bowl depth (mm)	Radius corner left bowl	Overflow LH bowl	Strainer position LH bowl	Strainer dimension LH bowl
LH Bowl	Traditional	330 x 420 x 210	210	80	Yes, traditional	Side bowl	3.5"

## Technical Features



<b>Characteristics composite material</b>	Antibacterial, Easy to clean, Anti-scratch, Thermal shock resistant, High temperatures resistant, Impact resistant, UV Resistant	<b>Tap hole</b>	2
<b>Frame depth (mm)</b>	10	<b>Tap hole diameter</b>	35 mm
<b>Dimensions of the product (mm)</b>	210x860x500 mm	<b>Drainer inclination</b>	2°
		<b>No. of clips</b>	8
		<b>Type of clips</b>	Standard
		<b>Possibility to install waste disposal</b>	Yes

---

Cutout dimension topmount (mm)	840 X 480 mm
Undermount cutout radius	30 mm
Height from kitchen top	10 mm
Base unit size	45 cm

## Accessories included

---

Accessories for installation	Strainer, Savespace siphon with dishwasher outlet connection, Fixing clips
------------------------------	--

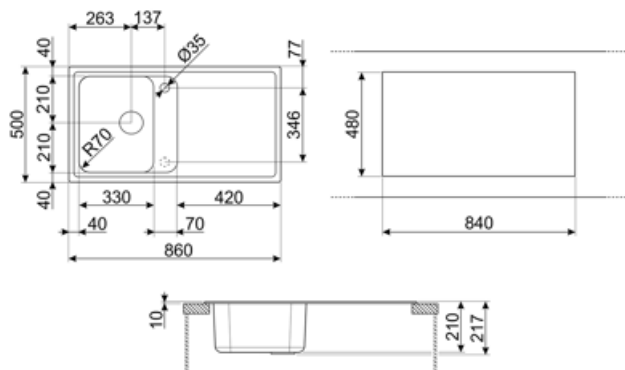

---

## Compatible Accessories

---



### **KITDSQ**

Soap dispenser chrome finishing with square knob 40x40 mm



### **KITFD075**

Waste disposal 0,75 HP, Motor: 1/2 horsepower, Fits all sinks with 3 1/2" waste outlet



### **KITFD050**

Waste disposal 0,5 HP, Motor: 1/2 horsepower, Fits all sinks with 3 1/2" waste outlet



### **KITFD100**

Waste disposal 1 HP, Motor: 1/2 horsepower, Fits all sinks with 3 1/2" waste outlet

---

## Alternative products

---

**LZ861AV2**

**Colour: Oats**



**LZ861CT**

**Colour: Cement / Concrete**



**LZ861A2**

**Colour: Anthracite**



**LZ861B**











**Colour: White**



---

## Symbols glossary

---

	Antibacterial		Antiscratch
	Cupboard width required for sink installation.		Sink depth - depending on the model, the depth can be from 13 to 24,5.
	Standard installation: Traditional installation in tabletop, suitable for any kitchen sets.		Thermal shock resistant
	High temperatures resistant		Impact resistant
	Easy to clean		Thanks to the double tap hole, most of our sinks are easily reversible, giving you the flexibility to make any type of kitchen composition.
	UV protection, does not fade over time.		