

# LZ861P

Materiale	Composito
Tipologia	Lavello composito
Numero vasche	1
Gocciolatoio	Reversibile
Codice EAN	8017709183172



## Estetica



Estetica	Universale	Logo	Applicato/Inciso TP
Colore	Panna	Altri colori disponibili	Bianco, Antracite, Avena, Rame, Cemento / Concrete
Serie	Rigae	Forato / predisposto per foratura	Predisp.
Tipo incasso	Standard		

	Tipologia vasca sx	Dimensioni vasca sx, L x P x A (mm)	Profondità vasca sx (mm)	Raggio angolare vasca sx	Trooppieno vasca sx	Posizione scarico vasca sx	Dimensione scarico vasca sx
Vasca sx	Tradizionale	330 x 420 x 210	210	80	Si, tradizionale	Laterale vasca	3.5"

## Caratteristiche Tecniche



<b>Caratteristiche materiale composito</b>	Antibatterico, Facile da pulire, Antiraffio, Resistente agli shock termici, Resistente alle temperature elevate, Resistente agli urti, Resistente ai raggi UV	<b>Foro miscelatore</b>	2
<b>Profondità invaso (mm)</b>	10	<b>Diametro foro miscelatore</b>	35 mm
<b>Dimensioni del prodotto (mm)</b>	210x860x500 mm	<b>Inclinazione gocciolatoio</b>	2 °
		<b>Numero ganci</b>	8
		<b>Tipologia ganci</b>	Standard
		<b>Possibilità di installare il tritarifiuti</b>	Si

Dimensioni foro incasso 840 X 480 mm  
sopratop (mm)  
Raggio angolare foro 30 mm  
incasso sottotop  
Altezza da top cucina 10 mm  
Misura mobile incasso 45 cm

## Dotazione accessori Inclusi

Dotazione accessori  
montaggio Piletta, Sifone salvaspazio  
con attacco lavastoviglie,  
Ganci montaggio

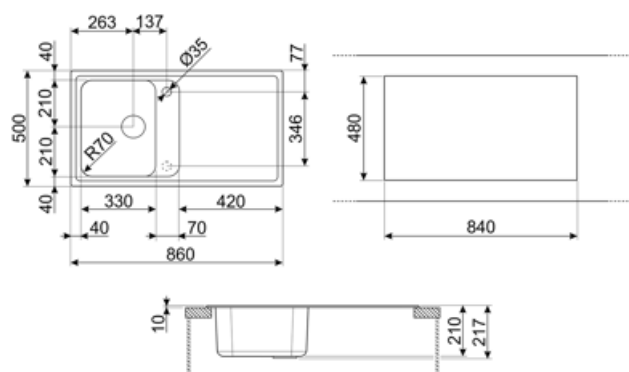

---

## Accessori Compatibili

---



### **KITDSQ**

Dispenser di sapone finitura cromata con manopola quadrata 40x40 mm



### **KITFD075**

Tritarifiuti 0,75 HP, Motore: 1/2 potenza, Adatto a tutti i lavelli con scarico da 3 1/2 "



### **KITFD050**

Tritarifiuti 0,5 HP, Motore: 1/2 potenza, Adatto a tutti i lavelli con scarico da 3 1/2 "



### **KITFD100**

Tritarifiuti 1 HP, Motore: 1/2 potenza, Adatto a tutti i lavelli con scarico da 3 1/2 "

---

## Prodotti alternativi

---

**LZ861AV2**

**Colore:** Avena



**LZ861CT**

**Colore:** Cemento



**LZ861A2**

**Colore:** Antracite













**LZ861B**

**Colore:** Bianco



## Glossario simboli

	Antibatterico		Antigraffio
	Dimensione del mobile base: Dimensione del mobile base necessaria per l'installazione del lavello.		Indica la profondità della vasca.
	Standard: modalità di installazione, che si abbina facilmente a qualsiasi tipo di cucina.		Facile da pulire
	Resistente agli shock termici		Resistente alle temperature elevate
	Resistente agli urti		Grazie al doppio foro per miscelatore, la maggior parte dei nostri lavelli è facilmente reversibile, offrendoti la flessibilità necessaria per realizzare qualsiasi tipo di composizione cucina.
	Protezione UV, non scolorisce nel tempo.		