

# LZ862A2

Sink material Composite  
 Type Composite sink  
 No. of bowls 2  
 EAN code 8017709251703



## Aesthetics



Aesthetic Universale  
 Series Rigae  
 Colour Anthracite  
 Building in type Standard  
 Logo Applied  
 Alternative colours available White, Cream, Beige, Copper, Cemento / Concrete  
 Tap hole / precut tap hole Prepared

	Bowl type RH	Bowl dimensions, WxDxH (mm)	Bowl depth (mm)	Radius corner right bowl (mm)	Overflow	Strainer position	Strainer dimension
RH Bowl	Traditional	371 x 420 x 210	210	80	Yes, traditional	Side bowl	3.5"
LH Bowl	Traditional	371 x 420 x 210	210	80		Side bowl	3.5"

## Technical Features



**Characteristics composite material**

Antibacterial, Easy to clean, Anti-scratch, Thermal shock resistant, High temperatures resistant, Impact resistant, UV Resistant

Frame depth (mm)

10

**Base unit size**

90 cm

**Tap hole**

2

**Tap hole diameter**

35 mm

**Dividing wall width**

38 mm

**No. of clips**

8

**Type of clips**

Standard

Dimensions of the product (mm)	210x860x500 mm
Cutout dimension topmount (mm)	840 X 480 mm
Undermount cutout radius	30 mm
Height from kitchen top	10 mm

## Accessories Included

Accessories for installation	Strainer, Savespace siphon with dishwasher outlet connection, Fixing clips
------------------------------	--

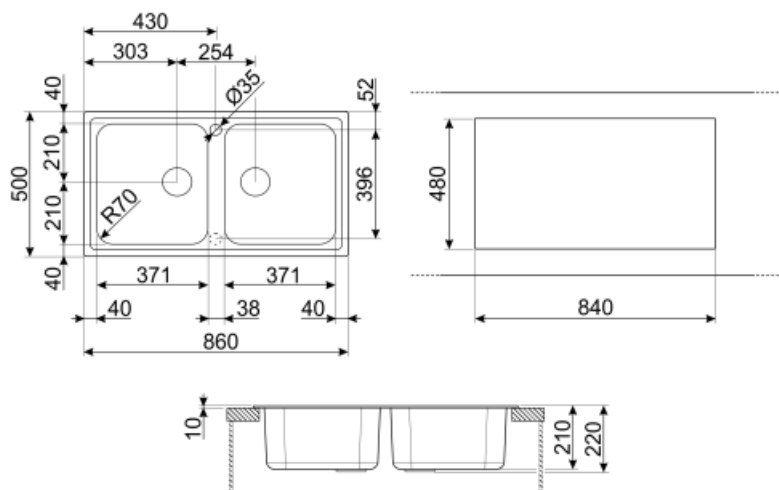

---

## Not included accessories

---



### **KITFD050**

Waste disposal 0,5 HP, Motor: 1/2 horsepower, Fits all sinks with 3 1/2" waste outlet



### **KITDSQ**

Soap dispenser chrome finishing with square knob 40x40 mm



### **KITFD100**

Waste disposal 1 HP, Motor: 1/2 horsepower, Fits all sinks with 3 1/2" waste outlet













### **KITFD075**

Waste disposal 0,75 HP, Motor: 1/2 horsepower, Fits all sinks with 3 1/2" waste outlet

---

## Symbols glossary (TT)

---

	Antibacterial		Antiscratch
	Cupboard width required for sink installation		Sink depth - depending on the model, the depth can be from 13 to 24,5
	Standard installation: Traditional installation in tabletop, suitable for any kitchen sets		Thermal shock resistant
	High temperatures resistant		Impact resistant
	Easy to clean		UV protection, does not fade over time.