

# LZ862AV2

Sink material	Composite
Type	Synthetic sink
No. of bowls	2
Drainer	Reversible
EAN code	8017709274535



## Aesthetics



<b>Aesthetic</b>	Universal	<b>Logo</b>	Applied/on overflow
<b>Serie</b>	Rigae	<b>Alternative colours available</b>	White, Anthracite, Cream, Copper, Cemento / Concrete
<b>Colour</b>	Oats	<b>Half bowl cup drainer</b>	No
<b>Building in type</b>	Standard	<b>Tap hole / precut tap hole</b>	Prepared

	Bowl type RH	Bowl dimensions, WxDxH (mm)	Bowl depth (mm)	Radius corner right bowl (mm)	Overflow	Strainer position	Strainer dimension
RH Bowl	Traditional	371 x 420 x 210	210	80	Yes, traditional	Side bowl	3.5"
LH Bowl	Traditional	371 x 420 x210	210	80	Yes, traditional	Side bowl	3.5"

## Technical Features



### Características do material composto

Válvula de escoamento, Fácil de limpar, Sifão com ligação à máquina de lavar louça, Resistente a choques térmicos, Ganchos de fixação, Vedantes, Resistente a UV

<b>Diâmetro do furo da torneira</b>	35 mm
<b>Popup command</b>	No
<b>Dividing wall width</b>	38 mm
<b>Pre-assembled gasket</b>	No
<b>No. of clips</b>	8

Frame depth (mm)	10	Type of clips	Standard
Dimensions of the product (mm)	220x860x500 mm		
Cutout dimension topmount (mm)	840 X 480 mm		
Height from kitchen top	10 mm		
Base unit size	90 cm		
Tap hole	2		

## Accessories Included

Accessories for installation	Strainer, Siphon with dishwasher outlet connection, Fixing clips	Basket	No
Colander	No	Wooden board	No
Rondò Cover waste kit	No	White board	No
Glass board	No		

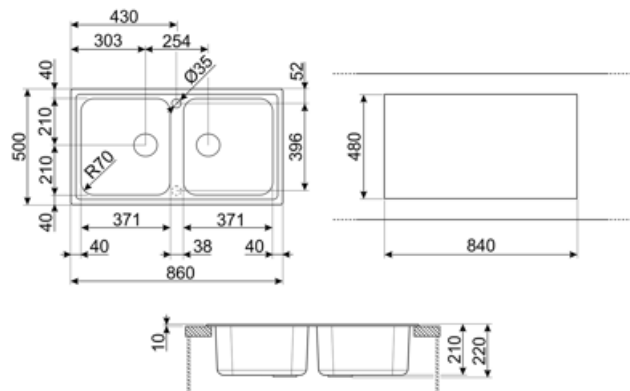

---

## Compatible Accessories

---



### **KITDSQ**

Botão quadrado do dispensador de sabão



### **KITFD075**

Eliminação de resíduos 0,75 CV Motor: 3/4 CV Adapta-se a todas as pias com saída de resíduos de 3 1/2"



### **KITFD050**











Eliminação de resíduos 0,5 CV Motor: 1/2 cv Serve para todas as pias com saída de resíduos de 3 1/2"



### **KITFD100**

Eliminação de resíduos 1 CV Motor: 1 cv Serve para todas as pias com saída de resíduos de 3 1/2"

## Symbols glossary

	Largura do armário necessária para a instalação da pia		Profundidade da pia - dependendo do modelo, a profundidade pode ser de 13 a 24,5
	Instalação padrão: Instalação tradicional em tampo de mesa, adequado para qualquer conjunto de cozinha		Antisséptico
	Antirrisco		Resistente a choques térmicos
	Resistente a altas temperaturas		Resistente a impactos
	Fácil de limpar		Graças ao furo duplo para torneira, a maioria de nossas pias são facilmente reversíveis, dando-lhe a flexibilidade de fazer qualquer tipo de composição de cozinha.
	A proteção UV, não se desvanece com o tempo.		

## Benefit (TT)

---

### **Two bowls**

Two bowls for greater versatility and dual functionality

### **Drainer**

The drawer allows dishes, cutlery and kitchen utensils to be placed directly on the sink after washing: excess water can drain into the sink, allowing for natural drying

### **Double tap hole**

The sink is easily reversible, making it possible to create any type of kitchen composition

### **Tap hole possibility**

Possibility of having the tap hole for direct installation of the tap on the sink, for a larger and neater surface area