

# LZ862CT

Materiale	Composito
Tipologia	Lavello composito
Numero vasche	2
Codice EAN	8017709251710

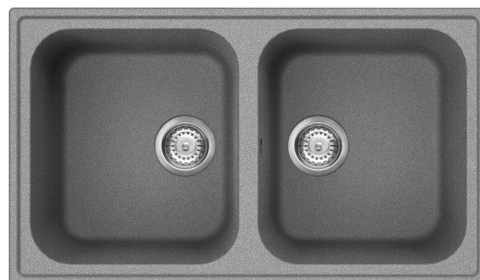

## Estetica



<b>Serie</b>	Rigae	<b>Logo</b>	Applicato/Inciso TP
<b>Estetica</b>	Universale	<b>Altri colori disponibili</b>	Bianco, Antracite, Panna, Avena, Rame, Cemento / Concrete
<b>Colore</b>	Cemento		
<b>Tipo incasso</b>	Standard	<b>Forato / predisposto per foratura</b>	Predisp.

	Tipologia vasca dx	Dimensioni vasca dx, L x P x A (mm)	Profondità vasca dx (mm)	Raggio angolare vasca dx	Trooppieno vasca	Posizione scarico vasca	Dimensione scarico vasca
Vasca dx	Tradizionale	371 x 420 x 210	210	80	Si, tradizionale	Laterale vasca	3.5"
Vasca sx	Tradizionale	371 x 420 x 210	210	80		Laterale vasca	3.5"

## Caratteristiche Tecniche



<b>Caratteristiche materiale composito</b>	Antibatterico, Antigraffio, Resistente agli shock termici, Resistente alle temperature elevate, Resistente agli urti, Facile da pulire, Resistente ai raggi UV	<b>Misura mobile incasso</b>	90 cm
		<b>Foro miscelatore</b>	2
		<b>Diametro foro miscelatore</b>	35 mm
		<b>Larghezza cavallotto</b>	38 mm
		<b>Numero ganci</b>	8
<b>Profondità invaso (mm)</b>	10	<b>Tipologia ganci</b>	Standard

Dimensioni del prodotto (mm) 210x860x500 mm

Dimensioni foro incasso sopratop (mm) 840 X 480 mm

Raggio angolare foro incasso sottotop 30 mm

Altezza da top cucina 10 mm

## Dotazione Accessori Inclusi

Dotazione accessori montaggio Piletta, Sifone salvaspazio con attacco lavastoviglie, Ganci montaggio

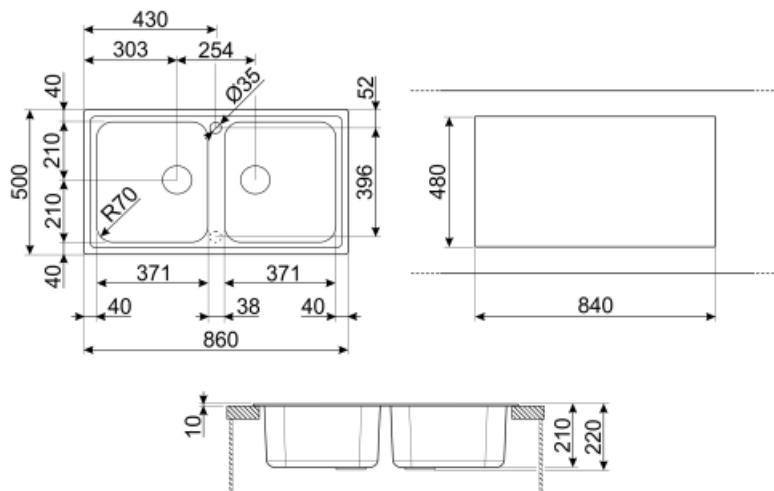

## Accessori non inclusi



### KITFD050

Tritarifiuti 0,5 HP, Motore: 1/2 potenza,  
Adatto a tutti i lavelli con scarico da 3  
1/2 "



### KITDSQ

Dispenser di sapone finitura cromata  
con manopola quadrata 40x40 mm



### KITFD050UK

Tritarifiuti 0,5 HP, Motore: 1/2 potenza,  
Adatto a tutti i lavelli con scarico da 3  
1/2 ", UK

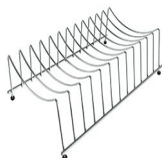

### COLPTX

Base scolapiatti 300 x 185 x 82 mm



### KITFD100

Tritarifiuti 1 HP, Motore: 1/2 potenza,  
Adatto a tutti i lavelli con scarico da 3  
1/2"



### KITFD075

Tritarifiuti 0,75 HP, Motore: 1/2  
potenza, Adatto a tutti i lavelli con  
scarico da 3 1/2 "













### DBSINT34

Cestello in acciaio / acciaio adatto per  
lavelli in composito con raggio STD  
vasca da 340 x 400 mm, profondità  
180 mm

---

## Glossario simboli

---

	Antibatterico		Antigraffio
	Dimensione del mobile base: Dimensione del mobile base necessaria per l'installazione del lavello.		Indica la profondità della vasca.
	Standard: modalità di installazione, che si abbina facilmente a qualsiasi tipo di cucina.		Facile da pulire
	Resistente alle temperature elevate		Resistente agli urti
	Resistente agli shock termici		Protezione UV, non scolorisce nel tempo.