

## MID5CR



Product family	Taps
Material	Brass
Swivelling spout	Yes
Swivelling spout rotation	180 °



## Aesthetics

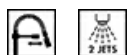

Aesthetic	Universale	Handshower	Mobile semi-professional
Colour	Chrome	Jet type	Double jets
Finishing	Glossy	Aerator	Yes
Spout type	Spring spout	Flexible hoses number	2
Tap type	Semi-professional single lever		

## Technical Features

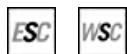

Characteristics	ESC, WSC	Minimum pressure	1 bar
Flexible hoses lenght	500 mm	Optimal pressure	3 bar
Flexible hoses connection	3/8 "	Water production (l/min)	12 l
Ceramic disc cartridge type	35 Ø	Tap hole diameter	35 mm
Maximum pressure	5 bar		

## Logistic Information

Product height (mm)	550 mm
---------------------	--------

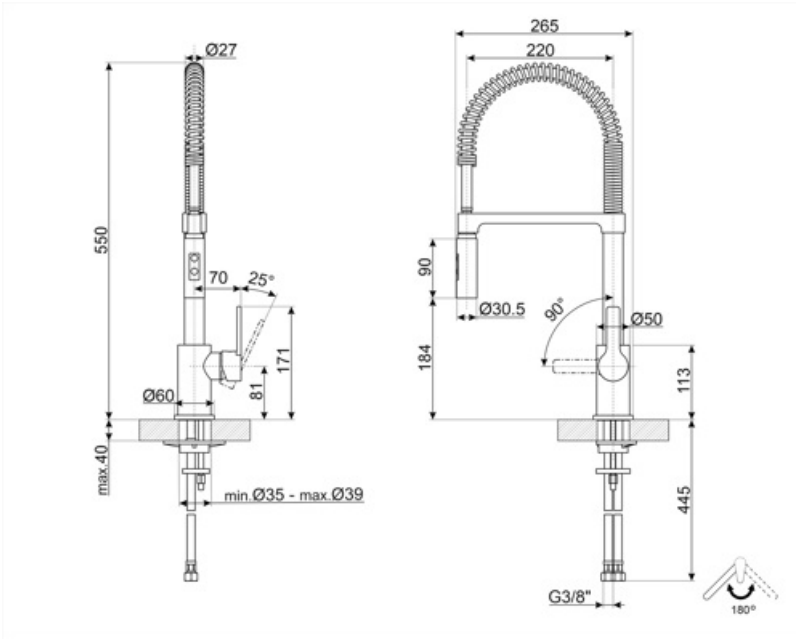

---

## Compatible Accessories

---







**STABMIX**  
Tap stabiliser

---

## Symbols glossary

---

- |   |  |
|---|--|
|  ESC: with the ESC Energy Saving Cartridge system the control lever positioned in the middle dispenses only cold water, and not 50% of hot and 50% of c |  WSC: with the WSC Water Saving Cartridge the control lever stops halfway, causing 50% of the water (sufficient for normal cooking activities) to be di |
|  Swivel spout rotation 180°   |  Double jet handshower. It is possible to simply switch between a standard stream mode and a spray mode.  |
|  The mobile hand shower of the Semi-Professional taps with high spout allows you to easily reach every point of the sink.                               |  |

## Benefit (TT)

---

### **Mobile shower semi-professional**

Practical mobile shower to easily reach every point of the sink

The mobile shower of the semi-professional taps with high spout allows you to easily reach every point of the sink for more practical and comfortable use, as well as easier cleaning

### **Energy Saving Cartridge**

Energy saving thanks to the special Energy Saving Cartridge (ESC) function

With the ESC function, the tap lever set in a central position supplies only cold water, instead of mixed cold and hot water as usual, saving in energy consumption. For hot water, the lever must be turned to the left

### **Water Saving Cartridge**

Water consumption can be reduced thanks to the special Water Saving Cartridge (WSC) function

With the WSC function, the tap lever stops first halfway, providing only 50% of the normal water flow, reducing water consumption. It is possible to deliver 100% water flow by completely opening the tap lever

Spout rotation 180°

### **Double jet**

Double jet shower to meet different needs in the kitchen

The double jet shower offers the possibility of simply switching between standard and spray modes for greater convenience and versatility