

MIDR55CR



Product family	Taps
Material	Brass
Swivelling spout	Yes
Swivelling spout rotation	180 °



Aesthetics



Aesthetic	Universale	Handshower	Mobile semi-professional
Colour	Chrome	Jet type	Double jets
Finishing	Glossy	Aerator	Yes
Spout type	Spring spout	Flexible hoses number	2
Tap type	Semi-professional single lever		

Technical Features

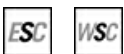

Characteristics	ESC, WSC	Minimum pressure	1 bar
Flexible hoses lenght	500 mm	Optimal pressure	3 bar
Flexible hoses connection	3/8 "	Water production (l/min)	12 l
Ceramic disc cartridge type	35 Ø	Tap hole diameter	35 mm
Maximum pressure	5 bar		

Logistic Information

Product height (mm)	480 mm
---------------------	--------

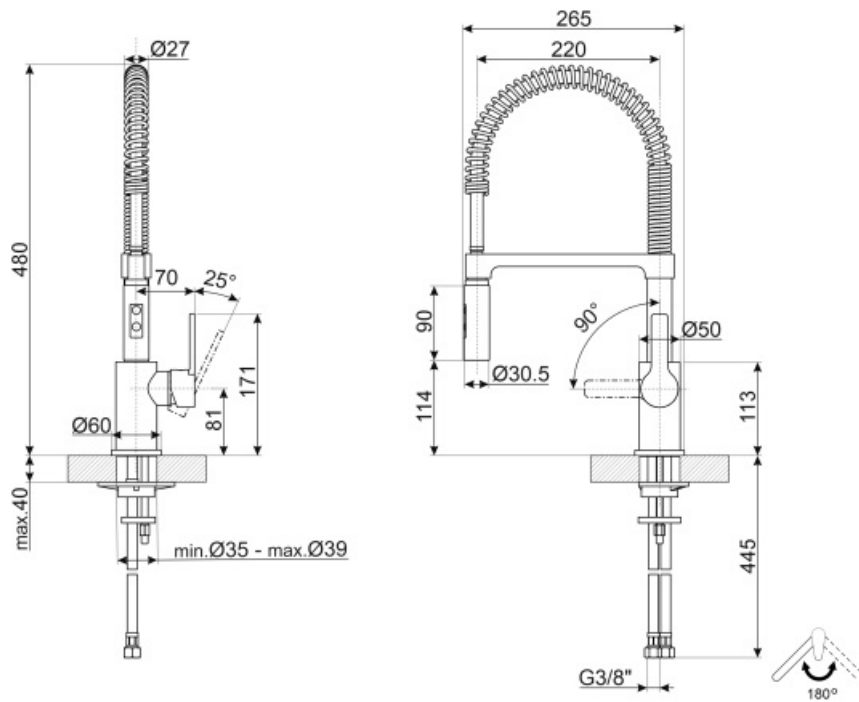





Not included accessories



STABMIX
Tap stabiliser

Symbols glossary (TT)

- | | | | |
|--|--|---|--|
|  | ESC: with the ESC Energy Saving Cartridge system the control lever positioned in the middle dispenses only cold water, and not 50% of hot and 50% of c |  | WSC: with the WSC Water Saving Cartridge the control lever stops halfway, causing 50% of the water (sufficient for normal cooking activities) to be di |
|  | Swivel spout rotation 180° |  | Double jet handshower. It is possible to simply switch between a standard stream mode and a spray mode. |
|  | The mobile hand shower of the Semi-Professional taps with high spout allows you to easily reach every point of the sink. | | |