

# MIDR7CR-2



Product family	Taps
Material	Brass
Swivelling spout	Yes
Swivelling spout rotation	180 °



## Aesthetics



Aesthetic	Coloniale	Handshower	Mobile semi-professional
Colour	Chrome	Jet type	Double jets
Spout type	Spring spout	Aerator	Yes
Tap type	Semi-professional single lever	Flexible hoses number	2
Finishing	Glossy		

## Technical Features

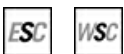

Characteristics	ESC, WSC	Optimal pressure	3 bar
Flexible hoses lenght	500 mm	Water production (l/min)	12 l
Flexible hoses connection	3/8 "	Ceramic disc cartridge type	35 Ø
Maximum pressure	5 bar	Tap hole diameter	35 mm
Minimum pressure	1 bar		

## Logistic Information

Product height (mm)	550 mm
---------------------	--------



---

## Compatible Accessories

---



**STABMIX**  
Tap stabiliser

---

## Alternative products

---



**MIDR7RA-2**

Colour: Copper







**MIDR7O-2**

Colour: Brass

---

## Symbols glossary

---

- |   |  |
|---|--|
|  ESC: with the ESC Energy Saving Cartridge system the control lever positioned in the middle dispenses only cold water, and not 50% of hot and 50% of c |  WSC: with the WSC Water Saving Cartridge the control lever stops halfway, causing 50% of the water (sufficient for normal cooking activities) to be di |
|  Swivel spout rotation 180°   |  Double jet handshower. It is possible to simply switch between a standard stream mode and a spray mode.  |
|  The mobile hand shower of the Semi-Professional taps with high spout allows you to easily reach every point of the sink.                               |  |