

MIDR7CR-2



Familia	Grifo
Material	Latón
Caño giratorio	Sí
Rotación caño giratorio	180 °



Estética

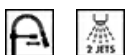

Estética	Colonial	Perforado / predispuesto para la perforación	Mobile semi-professional
Color	Cromado	Jet type	Double jets
Acabados	Brillante	Aireador	Sí
Spout type	Spring spout	Número de mangueras flexibles	2
Tipo de grifo	Semi-professional mono mando		

Características técnicas



Características	ESC, WSC	Presión mínima	1 bar
Longitud mangueras flexibles	500 mm	Presión óptima	3 bar
Conexión de mangueras flexibles.	3/8 "	Water production (l/min)	12 l
Tipo de cartucho	35 Ø	Diámetro del orificio del grifo	35 mm
Presión máxima	5 bar		

Datos logísticos

Altura del producto (mm)	550 mm
-----------------------------	--------

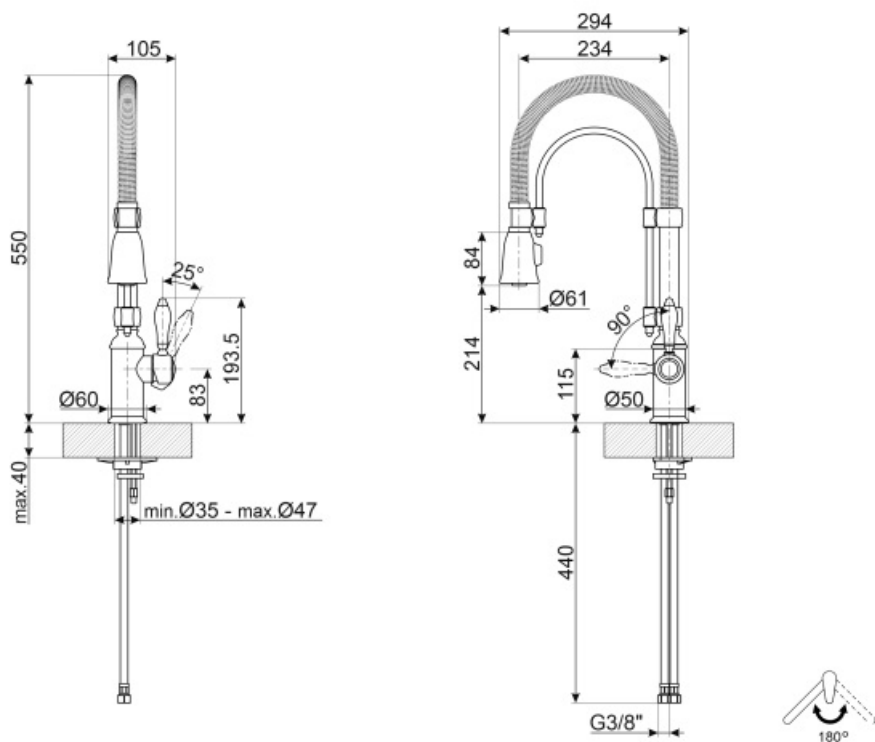





Not included accessories



STABMIX
Tap stabiliser

Symbols glossary (TT)

- | | |
|---|---|
|  <p>ESC: con el sistema de cartucho de ahorro de energía ESC, la palanca de control colocada en el centro suministra solo agua fría, y no 50% de calor y 50% de frío. Para obtener agua caliente, gire la palanca más hacia la izquierda. Por lo tanto, el uso no opera la caldera.</p> |  <p>WSC: con el sistema WSC Water Saving Cartridge, la palanca de control se detiene a la mitad, permitiendo que el mezclador dispense el 50% del agua (suficiente para las actividades normales de la cocina) para ahorrar en el consumo de agua.</p> |
|  <p>Swivel spout rotation 180°</p> |  <p>Double jet handshower. It is possible to simply switch between a standard stream mode and a spray mode.</p> |
|  <p>The mobile hand shower of the Semi-Professional taps with high spout allows you to easily reach every point of the sink.</p> | |