

MIDR70-2



Product family	Machos
Material	Brass
Bico giratório	Yes
Rotação do bico giratório	180 °



Aesthetics

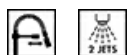

Aesthetic	Colonial	Alça para abastecimento de água filtrada	No
Colour	Brass	Handshower	Single jet
Acabamento	Antique brass	Tipo de jato	Jatos duplos
Tipo de bico	Bico de mola	Dispositivo de arejamento	Yes
Tap type	Alavanca única semiprofissional	Número de mangueiras flexíveis	2

Technical Features



Características	Esc, WSC	Pressão máxima	5 bar
Comprimento das mangueiras flexíveis	500 mm	Pressão mínima	1 bar
Conexão de mangueiras flexíveis	3/8 "	OTIMIZAÇÃO DA PRESSÃO	3 bar
Tipo de cartucho de disco cerâmico	35 Ø	Water production (l/min)	12 l
Filtro de depuração de água	No	Diâmetro do furo da torneira	35 mm

Logistic Information

Product height (mm)	550 mm
---------------------	--------

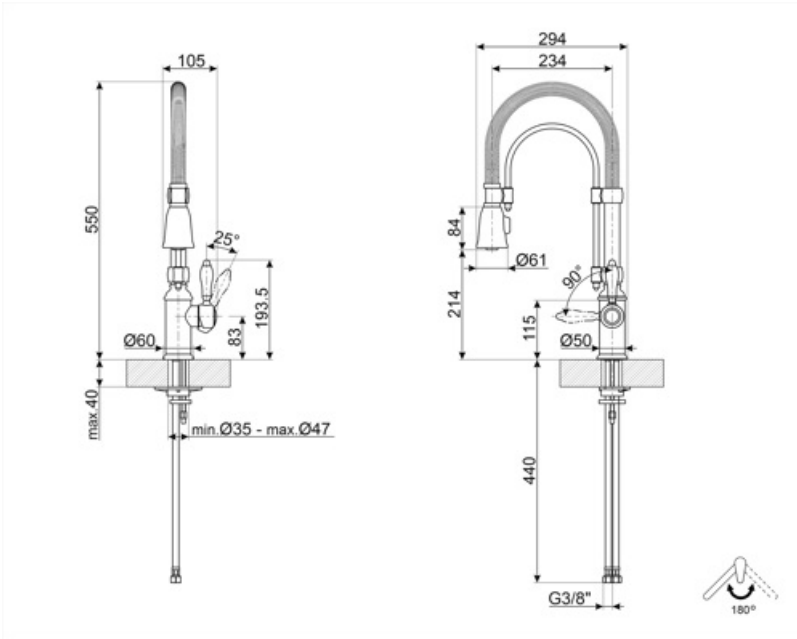





Compatible Accessories



STABMIX

estabilizador para misturadores

Symbols glossary

- | | | | |
|--|---|---|--|
|  | ESC: com o sistema ESC Energy Saving Cartridge, a alavanca de controle posicionada no meio dispensa apenas água fria, e não 50% de água quente e 50% de água fria |  | WSC: com o Cartucho de Poupança de Água WSC, a alavanca de controle para a meio caminho, fazendo com que 50% da água (suficiente para atividades de cozimento normais) seja dispensada |
|  | Rotação do bico giratório 180° |  | Duche de jato duplo. É possível simplesmente alternar entre um modo de fluxo padrão e um modo de spray. |
|  | O chuveiro de mão móvel das torneiras Semi-Profissionais com bico alto permite alcançar facilmente cada ponto da pia. | | |

Benefit (TT)

Mobile shower semi-professional

Practical mobile shower to easily reach every point of the sink

The mobile shower of the semi-professional taps with high spout allows you to easily reach every point of the sink for more practical and comfortable use, as well as easier cleaning

Energy Saving Cartridge

Energy saving thanks to the special Energy Saving Cartridge (ESC) function

With the ESC function, the tap lever set in a central position supplies only cold water, instead of mixed cold and hot water as usual, saving in energy consumption. For hot water, the lever must be turned to the left

Water Saving Cartridge

Water consumption can be reduced thanks to the special Water Saving Cartridge (WSC) function

With the WSC function, the tap lever stops first halfway, providing only 50% of the normal water flow, reducing water consumption. It is possible to deliver 100% water flow by completely opening the tap lever

Spout rotation 180°

Double jet

Double jet shower to meet different needs in the kitchen

The double jet shower offers the possibility of simply switching between standard and spray modes for greater convenience and versatility