

# MOE25X



Produktfamilie	Mikrobølge
Kategori	Fritstående
Installationstype	Fritstående
Energiltførsel	Elektrisk
Tilberedningsmetode	Mikrobølgeovn med grill
Ovnbetjening	Elektronisk



## Æstetik

Æstetik	Universal	Farve silketryk	Sort
Farve	Rustfrit stål	Låge	Med paneler
Farve kabinet	Rustfri	Håndtag	Universal
Komponentfinish	Forkromet	Håndtag farve	Forkromet
Materiale	Rustfrit stål	Logo	Silketryk
Type af stål	Børstet		

## Program / Funktioner



Antal funktioner	6	Optøning efter vægt	Ja
Fuld grill	Ja	Mikrobølge	Ja
Pizza	Ja	Mikrobølgeovn + grill	Ja
Optøning efter tid	Ja	Automatiske programmer	10

## Betjening

Display / ur	1 LED	Betjeningsknapper	Standard med rifler
Type af betjeningsindstilling	Knapper	Farve på knapper	Forkromet
Åbning	Håndtag	Farve på knapper	Krom
Ant. knapper	1		

## Valgmuligheder



<b>Timer</b>	Elektronisk	<b>Lydalarm for endt tilberedning</b>	Ja
<b>Timerindstillinger</b>	Forsinket start og slut på tilberedning	<b>Bejteningslås/børnesikring</b>	Ja

## Tekniske egenskaber



<b>Ovnrum materiale</b>	Keramisk emalje	<b>Lågeåbning</b>	Side-åbning
<b>Antal lamper</b>	1	<b>Samlet antal lågeglas</b>	1
<b>Lampetype</b>	Led	<b>Sikkerhedstermostat</b>	Ja
<b>Drejeskive</b>	Ja	<b>Kølesystem</b>	Tangentiel
<b>Dimensioner på drejeskive</b>	31,5 cm	<b>Beskyttelsesskærm til mikrobølgeovn</b>	Ja
<b>Belysning når lågen åbnes</b>	Ja	<b>Mikrobølgeovn standser, når lågen åbnes</b>	Ja
<b>Grilltype</b>	Varmelegeme	<b>Nettodimensioner for indvendigt rum (HxBxD)</b>	180x330x328 mm
<b>Grill - Effekt</b>	1000 W	<b>Mikrobølgeovn udgangseffekt</b>	900 W

## Medfølgende tilbehør

<b>Gitter</b>	1	<b>Pizzafad</b>	1
---------------	---	-----------------	---

## Ydeevne/energimærke









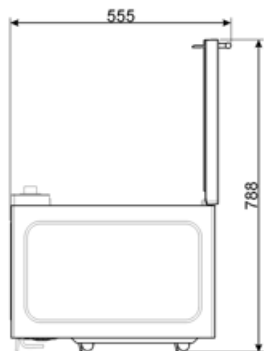
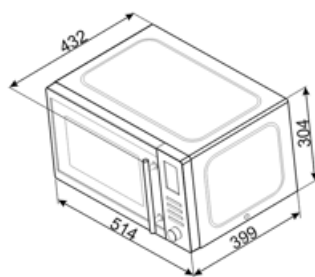
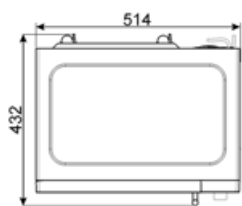



<b>Brugbart volumen</b>	25 l	<b>Bruttorumfang</b>	26 l
-------------------------	------	----------------------	------

## Elektrisk tilslutning

<b>Stik</b>	(F;E) Schuko	<b>Spænding (V)</b>	240 V
<b>Elektrisk tilslutning, normering (W)</b>	1500 W	<b>Frekvens (Hz)</b>	50 Hz
<b>Nuværende</b>	6,25 A	<b>Kabellængde</b>	100 cm



## Symbols glossary

-  Børnesikring: nogle modeller er udstyret med en enhed til at låse programmet / cyklussen, så det ikke på uheldigvis kan ændres.
-  Optøning på tid: Manuel optøningsfunktion. Ved afslutningen af den indstillede varighed stopper funktionen.
-  Fingeraftrykssikkert rustfrit stål: Fingeraftrykssikkert rustfrit stål får rustfrit stål til at se ud som nyt.
-  Mikrobølgeovn + grill-legeme: Brug af grillen resulterer i en perfekt bruning af madens overflade. Mikrobølger tillader i stedet for madlavning på kort tid den indre del af maden.
-  Mikroovn: Mikrobølger trænger direkte ind i maden og tilbereder meget hurtigt og med betydelige energibesparelser. Velegnet til madlavning uden fedt, de er også i stand til at tø og opvarme mad uden at ændre dets oprindelige udseende og aroma. Mikrobølgefunktionen kan også kombineres med konventionelle funktioner med alle de resulterende fordele. Ideel til alle typer mad.
-  Kapaciteten angiver mængden af anvendelig plads i ovnrummet i liter.
-  Mikrobølgeenergi forkorter tilberedningstiderne drastisk og giver energibesparelser.
-  Optøning ved vægt: Automatisk optøningsfunktion. Du vælger den madtype, der skal optøes fra de tilgængelige kategorier (KØD - FISK - BRØD - DESSERTER) Efter indtastning af madens vægt, definerer ovnen automatisk den tid, der kræves for korrekt optøning.
-  Grill: Meget intens varme kommer kun ovenfra fra et dobbelt varmeelement. Ventilatoren er ikke aktiv. Giver fremragende grill- og gratinerende resultater. Bruges i slutningen af madlavningen, giver det en ensartet bruning til retter.
-  Pizza mikrobølgeovn: Denne funktion tilbereder pizza hurtigere takket være mikrobølgerne. Brug funktionen kombineret med Chef-pladen for at optimere det endelige resultat
-  Sidelys: To modstående sidelygter øger synligheden inde i ovnen.