

MOE34CXIUK



Product Family	Microwave
Category	Countertop
Installation type	Countertop
Power supply	Electric
Cooking Method	Combi Microwave
Control	Electronic



Aesthetics

Aesthetic	Universale	Type of steel	Brushed
Colour	Stainless steel	Serigraphy colour	Black
Finishing	Fingerproof	Door	With panel
Colore Case	Inox	Handle	Universal
Components finishing	Chromed	Handle Colour	Chromed
Material	Stainless steel	Logo	Silk screen

Program / Functions

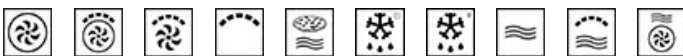

No. of functions	10	Defrost by time	Yes
Circolaire + fan	Yes	Defrost by weight	Yes
Circolaire + fan + grill	Yes	Microwave	Yes
Full grill + Fan	Yes	Microwave + grill	Yes
Full grill	Yes	Microwave + circulaire + fan	Yes
Pizza	Yes	Automatic programmes	23

Controls

Display / Clock	1 a LED	Control knobs	Standard with knurlings
Type of control setting	Control knobs / buttons	Controls colour	Chromed
Opening	Handle	Bottoms Colour	Cromato
No. of controls	1		

Options



Timer	Electronic	End of cooking acoustic alarm	Yes
Time-setting options	Start and stop	Controls Lock / Child Safety	Yes

Technical Features



Cavity material	Stainless steel	Door opening	Side-opening
No. of lights	1	Total no. of door glasses	2
Light type	Led	Safety Thermostat	Yes
Turntable	Yes	Cooling system	Tangential
Turntable dimensions	31,5 cm	Microwave screen protection	Yes
Light when door is opened	Yes	Microwave stops when door is opened	Yes
Grill type	Heating element	Inverter	Yes
Grill - power	1100 W	Usable cavity space dimensions (HxWxD)	249x351x361 mm
Circulaire heating element - Power	2500 W	Microwave effective power	1100 W

Accessories included

Grid	1
-------------	---

Performance / Energy Label









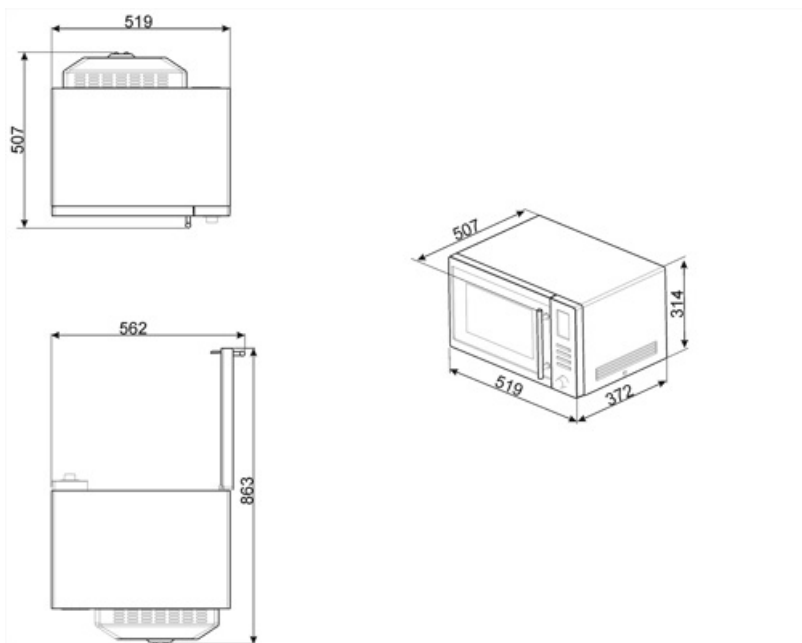









Usable volume	34 l	Gross volume	35 l
----------------------	------	---------------------	------

Electrical Connection

Plug	(G) UK e Singapore	Voltage (V)	230 V
Nominal power	1800 W	Frequency (Hz)	50 Hz
Current	7,83 A	Power supply cable length	100 cm



Symbols glossary

 <p>Child lock: some models are fitted with a device to lock the programme/cycle so it cannot be accidentally changed.</p>	 <p>Combination microwave: This oven allows to combine two different ways of cooking (Traditional with microwaves). Combined ovens increase cooking opportunities, while providing maximum flexibility of household appliances.</p>
 <p>Microwave energy shortens cooking times dramatically and produces energy savings.</p>	 <p>Defrost by time: Manual defrost function. At the end of the set duration, the function stops.</p>
 <p>Defrost by weight: Automatic defrost function. You choose the type of food to defrost from the available categories (MEAT - FISH - BREAD - DESSERTS). After entering the weight of the food, the oven automatically defines the time required for proper defrosting.</p>	 <p>Double glazed doors: Number of glazed doors.</p>
 <p>Fingerprint proof stainless steel: Fingerprint proof stainless steel keeps stainless steel looking as good as new.</p>	 <p>Circulaire + grill: Circulaire with upper element or grill: Similar to fan with upper element with the added cooking speed of circulaire, ideal for dishes with a crispy topping. When used with the grill the food will brown more quickly.</p>
 <p>Circulaire: it is the perfect function for cooking all types of dishes in a more delicate way. The heat comes from the back of the oven and is distributed quickly and evenly. The fan is active. It is also ideal for cooking on multiple levels without mixing smells and flavors.</p>	 <p>Grill: Very intense heat coming only from above from a double heating element. The fan is not active. Provides excellent grilling and gratinating results. Used at the end of cooking, it gives a uniform browning to dishes.</p>
 <p>Fan grill: very intense heat coming only from above from a double heating element. The fan is active. It allows the optimal grilling of thickest meats. Ideal for large cuts of meat.</p>	 <p>Cooking with the simultaneous use of the heating element in combination with fan and microwave supply.</p>
 <p>Microwave + grill element: The use of the grill results in a perfect browning of the surface of the food. The action of microwaves allows instead of cooking in a short time the internal part of the food.</p>	 <p>Pizza microwave: This function cooks pizza quicker thanks to the microwaves. To optimize the final result, use the function combined with the Chef plate.</p>
 <p>Microwave: Penetrating straight into the food, microwaves cook very quickly and with considerable energy savings. Suitable for cooking without fat, they are also able to thaw and heat food without altering its original appearance and aroma. The microwave function can also be combined with conventional functions with all the resulting advantages. Ideal for all types of food.</p>	 <p>Side lights: Two opposing side lights increase visibility inside the oven.</p>
 <p>The capacity indicates the amount of usable space in the oven cavity in litres.</p>	