

# MP122B3

Usable volume

22 l



Product Family

Microwave

Category

Built-in

Installation

Under cupboard

Power supply

Electric

Cooking Method

Microwave with grill

Control

Electronic



## Programme / Functions

No. of functions

6

Full grill



Pizza



Defrost by time



Defrost by weight



Microwave



Microwave + grill



## Controls

Display / Clock

1 a LED

No. of controls

2

Type of control setting

Control knobs

Control knobs

Linea

Opening

Mechanical button

## Options



Timer

Electronic

Showroom demo option Yes

Time-setting options

Start and stop

Controls Lock / Child Yes

End of cooking acoustic alarm

Yes

Safety

## Technical Features



<b>Cavity material</b>	Stainless steel	<b>Door opening</b>	Side-opening
<b>No. of lights</b>	1	<b>Total no. of door glasses</b>	2
<b>Light type</b>	Incandescent	<b>Safety Thermostat</b>	Yes
<b>Light Power</b>	20 W	<b>Cooling system</b>	Tangential
<b>Ceramic base</b>	Yes	<b>Microwave screen protection</b>	Yes
<b>Light when door is opened</b>	Yes	<b>Microwave stops when door is opened</b>	Yes
<b>Grill type</b>	Heating element	<b>Usable cavity space dimensions (HxWxD)</b>	220x350x280 mm
<b>Tilting grill</b>	Yes	<b>Microwave effective power</b>	850 W
<b>Grill - power</b>	1250 W		

## Accessories Included

Grid 1

## Electrical Connection

<b>Nominal power</b>	2700 W	<b>Frequency (Hz)</b>	50 Hz
<b>Current</b>	11 A	<b>Power supply cable length</b>	150 cm
<b>Voltage (V)</b>	220-240 V		

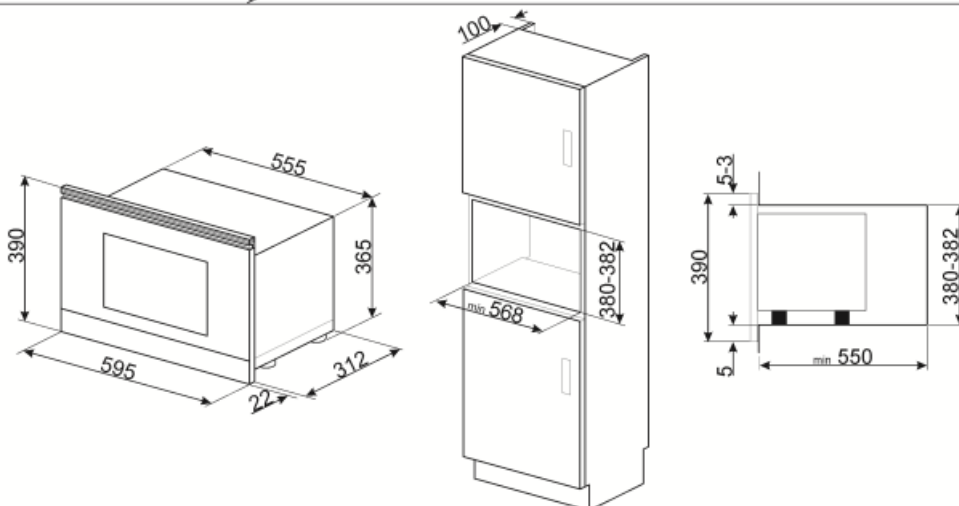
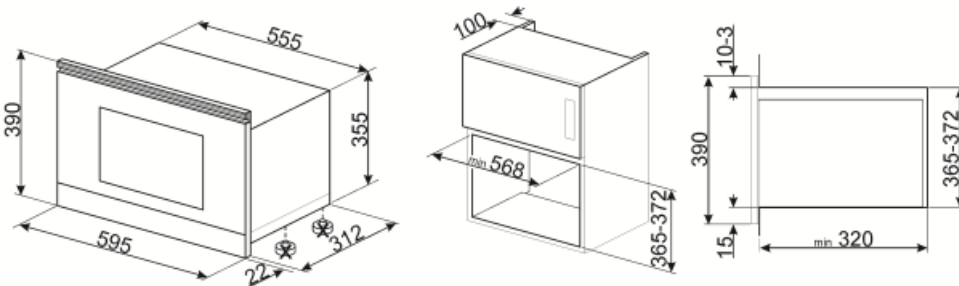

## Not included accessories

---



### **KITMP38**













Thin bar to change microwave ovens height from 39cm to 38cm



### **KITPLATE**

The dish baker is a Teflon-coated aluminum plate with the lower part of ferrous material immersed in a silicone rubber 26,5 cm edges of the flare, 25 cm base

## Symbols glossary (TT)

 <p>Surfaceplus ceramic base: Surfaceplus ceramic base for a microwave oven - no turntable required, and the whole surface can be used for cooking.</p>	 <p>Child lock: some models are fitted with a device to lock the programme/cycle so it cannot be accidentally changed.</p>
 <p>Microwave energy shortens cooking times dramatically and produces energy savings.</p>	 <p>Defrost by time: Manual defrost function. At the end of the set duration, the function stops.</p>
 <p>Defrost by weight: Automatic defrost function. You choose the type of food to defrost from the available categories (MEAT - FISH - BREAD - DESSERTS) After entering the weight of the food, the oven automatically defines the time required for proper defrosting.</p>	 <p>Double glazed doors: Number of glazed doors.</p>
 <p>Grill: Very intense heat coming only from above from a double heating element. The fan is not active. Provides excellent grilling and gratinating results. Used at the end of cooking, it gives a uniform browning to dishes.</p>	 <p>Microwave: Penetrating straight into the food, microwaves cook very quickly and with considerable energy savings. Suitable for cooking without fat, they are also able to thaw and heat food without altering its original appearance and aroma. The microwave function can also be combined with conventional functions with all the resulting advantages. Ideal for all types of food.</p>
 <p>Microwave + grill element: The use of the grill results in a perfect browning of the surface of the food. The action of microwaves allows instead of cooking in a short time the internal part of the food.</p>	 <p>Pizza microwave: This function cooks pizza quicker thanks to the microwaves. To optimize the final result, use the function combined with the Chef plate</p>
 <p>Tilting grill: the tilting grill can be easily unhooked to move the heating element and clean the roof of the appliance in one simple step.</p>	 <p>The capacity indicates the amount of usable space in the oven cavity in litres.</p>