

MP122B3

Bruikbare inhoud

22 l



Familie

Magnetron

Categorie

Inbouw

Installatie

Bovenkast

Voeding

Elektrisch

Bereidingswijze

Magnetron met grill

Bediening

Elektronisch



Programma's / functies

Aantal functies

6

Grote vlakgrill



Pizza



Ontdooien op tijd



Ontdooien op gewicht



Magnetron



Magnetron + grill



Bediening

Display / Klok

1 LED

Aantal

2

Type bediening

Bedieningsknoppen

bedieningsknoppen

Opening

Mechanical button

Bedieningsknoppen

Linea

Opties



Timer

Elektronisch

Showroom demo optie

Ja

Opties

Start en stop

Kinderbeveiliging

Ja

tijdprogrammering

Akoestisch signaal
einde kooktijd

Ja

Technische specificaties



Materiaal ovenruimte	Roestvrij staal	Deur openen	Side-opening
Aantal lampen	1	Totaal aantal ruiten	2
Soort verlichting	Gloeilamp	Veiligheidsthermostaat	Ja
Vermogen lamp	20 W	Koelsysteem	Mantelkoeling
Keramische basis	Ja	Veiligheidsscherm magnetrondeur	Ja
Automatische inschakeling verlichting bij openen deur	Ja	Automatische uitschakeling magnetron bij openen deur	Ja
Type grill	Verwarmingselement	Afmetingen bruikbare interne ovenruimte (hxbxd)	220x350x280 mm
Kantelbare grill	Ja	Effectief magnetronvermogen	850 W
Grill - vermogen	1250 W		

Meegeleverde accessoires

Ovenrooster	1
-------------	---

Elektrische aansluiting

Aansluitwaarde	2700 W	Frequentie (Hz)	50 Hz
Stroom	11 A	Lengte voedingskabel	150 cm
Spanning (V)	220-240 V		

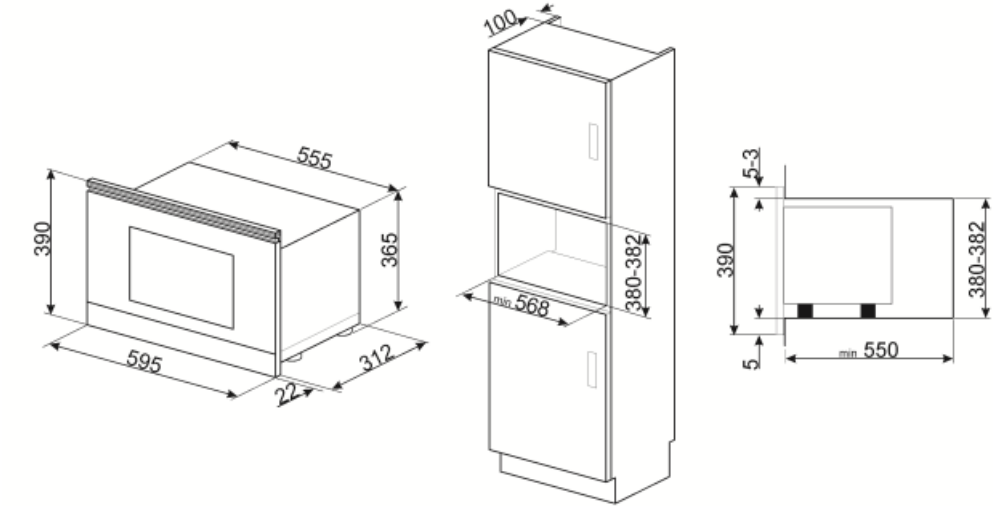
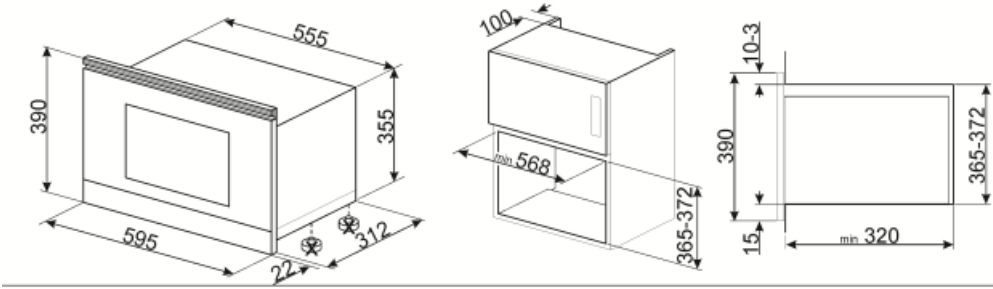













Accessoires niet inbegrepen

KITMP38

Thin bar to change microwave ovens height from 39cm to 38cm



Symbols glossary (TT)

	Surfaceplus ceramic base: Surfaceplus ceramic base for a microwave oven - no turntable required, and the whole surface can be used for cooking.		Kinderslot: sommige modellen zijn voorzien van een apparaat om het programma / de cyclus te vergrendelen zodat het niet kan per ongeluk veranderd
	Microwave energy shortens cooking times dramatically and produces energy savings.		Ontdooien op tijd: met deze functie wordt automatisch het tijdstip van ontdooien van voedsel bepaald
	Ontdooien op gewicht: Met deze functie wordt de ontdooitijd bepaald		Dubbele beglazing: aantal glazen deuren.
	De warmte wordt geproduceerd door het grill- en bovenelement. Verhitting over het volledige oppervlak. De thermostaat wordt, afhankelijk van het gerecht, in de regel op de maximale stand gezet. Bij een korte baktijd kan de oven deur gesloten blijven; bij langere baktijd blijft deze gedeeltelijk geopend. Voor vleesgerechten (klein- en middelgroot), vleespennen, vis, groenten, gratineren etc.		Microwave: Penetrating straight into the food, microwaves cook very quickly and with considerable energy savings. Suitable for cooking without fat, they are also able to thaw and heat food without altering its original appearance and aroma. The microwave function can also be combined with conventional functions with all the resulting advantages. Ideal for all types of food.
	Microwave + grill element: The use of the grill results in a perfect browning of the surface of the food. The action of microwaves allows instead of cooking in a short time the internal part of the food.		Pizza microwave: This function cooks pizza quicker thanks to the microwaves. To optimize the final result, use the function combined with the Chef plate
	Tilting grill: the tilting grill can be easily unhooked to move the heating element and clean the roof of the appliance in one simple step.		The capacity indicates the amount of usable space in the oven cavity in litres.