

# MP322X1

Beschikbaar volume

22 l



Product familie

Microgolfoven

Categorie

Inbouw 38 cm

Installatie

Bovenkast

Voeding

Elektrisch

Bereidingswijze

Microgolf met grill

Bediening

Elektronisch



## Programma's / Functies

Aantal functies

6

Grote vlakgrill



Pizza



Ontdooien op tijd



Ontdooien op gewicht



Microgolfoven



Microgolfoven + grill



## Bediening

Display / Klok

1 LED Display

Aantal

2

Type

Bedieningsknoppen

bedieningsknoppen

bedieningsmechanisme

Bedieningsknoppen

Classici

Opening

Mechanical button

## Opties



Timer

Elektronische timer

Showroom demo optie

Ja

Opties

Begin en einde

Kinderbeveiliging

Ja

tijdprogrammering

Geluidssignaal einde kooktijd Ja

## Technische specificaties



Materiaal ovenruimte	Inox ovenruimte	Opening deur	Side-opening
Aantal lampen	1	Totaal aantal ruiten	2
Type lamp	Gloeilamp	Veiligheidsthermostaat	Ja
Vermogen lamp	20 W	Koelsysteem	Mantelkoeling
Keramische basis	Ja	Veiligheidsscherm microgolfdeur	Ja
Automatische inschakeling verlichting bij openen deur	Ja	Automatische uitschakeling microgolf bij openen deur	Ja
Type grill	Verwarmingselement	Afmetingen bruikbare interne ovenruimte (hxbxd)	220x350x280 mm
Kantelbare grill	Ja	Effectief vermogen microgolf	850 W
Grill - vermogen	1250 W		

## Meegeleverde accessoires

Ovenrooster	1	Overig	Kit bedieningskoppen Elementi/ Selezione
-------------	---	--------	---

## Elektrische aansluiting

Nominale aansluitwaarde	2700 W	Frequentie (Hz)	50 Hz
Stroom	11 A	Lengte voedingskabel	150 cm
Spanning (V)	220-240 V		

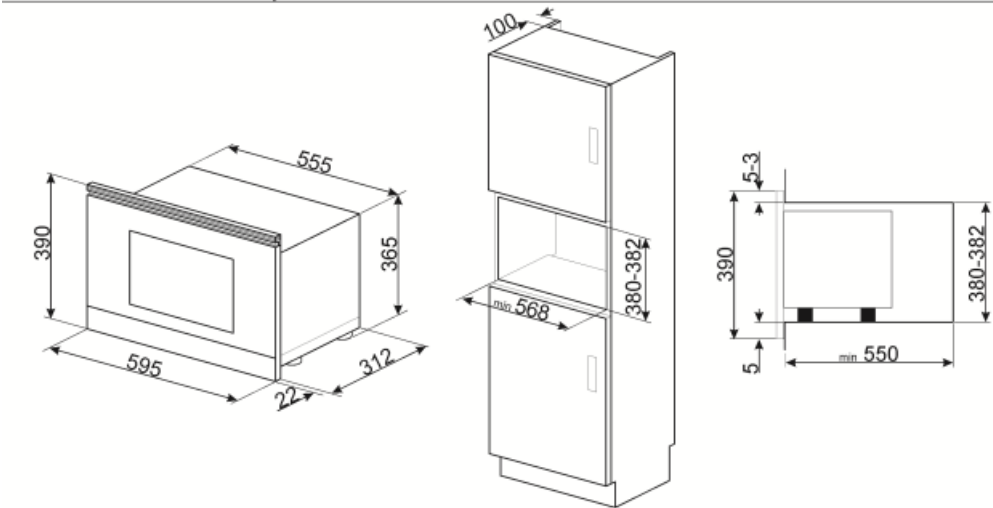
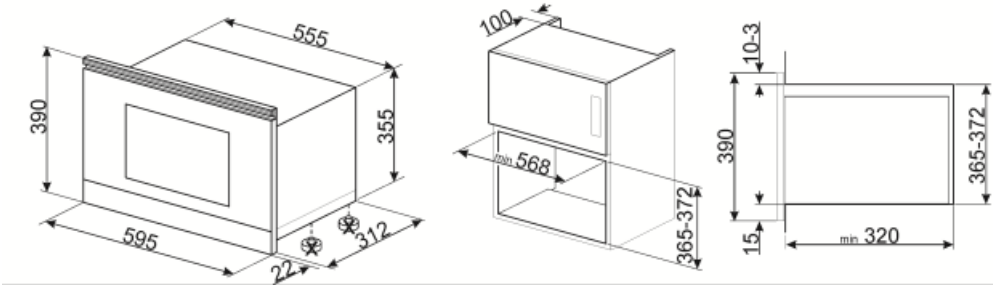

## Not included accessories

---



### KITMP38













Thin bar to change microwave ovens height from 39cm to 38cm



### KITPLATE

The dish baker is a Teflon-coated aluminum plate with the lower part of ferrous material immersed in a silicone rubber 26,5 cm edges of the flare, 25 cm base

## Symbols glossary (TT)

 <p>Surfaceplus ceramic base: Surfaceplus ceramic base for a microwave oven - no turntable required, and the whole surface can be used for cooking.</p>	 <p>Sommige modellen zijn voorzien van een functie om het programma/de cyclus te blokkeren zodat het niet per ongeluk kan aangepast worden.</p>
 <p>Microwave energy shortens cooking times dramatically and produces energy savings.</p>	 <p>Defrost by time: Manual defrost function. At the end of the set duration, the function stops.</p>
 <p>Defrost by weight: Automatic defrost function. You choose the type of food to defrost from the available categories (MEAT - FISH - BREAD - DESSERTS) After entering the weight of the food, the oven automatically defines the time required for proper defrosting.</p>	 <p>Double glazed doors: Number of glazed doors.</p>
 <p>Grill: Very intense heat coming only from above from a double heating element. The fan is not active. Provides excellent grilling and gratinating results. Used at the end of cooking, it gives a uniform browning to dishes.</p>	 <p>Microwave: Penetrating straight into the food, microwaves cook very quickly and with considerable energy savings. Suitable for cooking without fat, they are also able to thaw and heat food without altering its original appearance and aroma. The microwave function can also be combined with conventional functions with all the resulting advantages. Ideal for all types of food.</p>
 <p>Microwave + grill element: The use of the grill results in a perfect browning of the surface of the food. The action of microwaves allows instead of cooking in a short time the internal part of the food.</p>	 <p>Pizza microwave: This function cooks pizza quicker thanks to the microwaves. To optimize the final result, use the function combined with the Chef plate</p>
 <p>Tilting grill: the tilting grill can be easily unhooked to move the heating element and clean the roof of the appliance in one simple step.</p>	 <p>The capacity indicates the amount of usable space in the oven cavity in litres.</p>