

MP422S

Bruikbare inhoud

22 l



Familie

Magnetron

Categorie

Inbouw

Installatie

Bovenkast

Voeding

Elektrisch

Bereidingswijze

Magnetron met grill

Bediening

Elektronisch



Bediening

Display / Klok

1 LED

Type bediening

Bedieningsknoppen

Opening

Mechanical button

Aantal

bedieningsknoppen

2

Bedieningsknoppen

New Selezione

Opties



Timer

Elektronisch

Showroom demo optie

Ja

Opties

Start en stop

Kinderbeveiliging

Ja

tijdprogrammering

Akoestisch signaal
einde kooktijd

Ja

Technische specificaties



Materiaal ovenruimte

Roestvrij staal

Deur openen

Side-opening

Aantal lampen

1

Totaal aantal ruiten

2

Soort verlichting

Gloeilamp

Veiligheidsthermostaat

Ja

Vermogen lamp

20 W

Koelsysteem

Mantelkoeling

Keramische basis

Ja

Veiligheidsscherm

Ja

Automatische

Ja

magnetrondeur

inschakeling verlichting
bij openen deur

Automatische
uitschakeling magnetron
bij openen deur

Ja

Type grill

Verwarmingselement

Kantelbare grill

Ja

Grill - vermogen	1250 W	Afmetingen bruikbare interne ovenruimte (hxbxd)	220x350x280 mm
		Effectief magnetronvermogen	850 W

Meegeleverde accessoires

Ovenrooster	1
-------------	---

Elektrische aansluiting

Aansluitwaarde	2700 W	Frequentie (Hz)	50 Hz
Stroom	11 A	Lengte voedingskabel	150 cm
Spanning (V)	220-240 V		

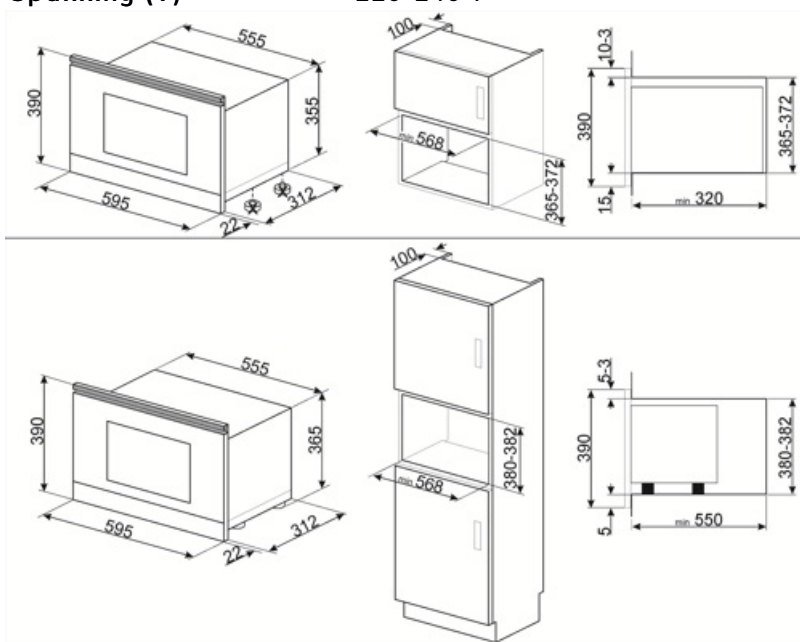













Compatibele Accessoires

KITMP38

Thin bar to change microwave ovens height from 39cm to 38cm



Symbols glossary

	Surfaceplus ceramic base: Surfaceplus ceramic base for a microwave oven - no turntable required, and the whole surface can be used for cooking.		Kinderslot: sommige modellen zijn voorzien van een apparaat om het programma / de cyclus te vergrendelen zodat het niet kan per ongeluk veranderd
	Microwave energy shortens cooking times dramatically and produces energy savings.		Ontdooien op tijd: met deze functie wordt automatisch het tijdstip van ontdooien van voedsel bepaald
	Ontdooien op gewicht: Met deze functie wordt de ontdooitijd bepaald		Dubbele beglazing: aantal glazen deuren.
	De warmte wordt geproduceerd door het grill- en bovenelement. Verhitting over het volledige oppervlak. De thermostaat wordt, afhankelijk van het gerecht, in de regel op de maximale stand gezet. Bij een korte baktijd kan de oven deur gesloten blijven; bij langere baktijd blijft deze gedeeltelijk geopend. Voor vleesgerechten (klein- en middelgroot), vleespennen, vis, groenten, gratineren etc.		Microwave: Penetrating straight into the food, microwaves cook very quickly and with considerable energy savings. Suitable for cooking without fat, they are also able to thaw and heat food without altering its original appearance and aroma. The microwave function can also be combined with conventional functions with all the resulting advantages. Ideal for all types of food.
	Microwave + grill element: The use of the grill results in a perfect browning of the surface of the food. The action of microwaves allows instead of cooking in a short time the internal part of the food.		Pizza microwave: This function cooks pizza quicker thanks to the microwaves. To optimize the final result, use the function combined with the Chef plate
	Tilting grill: the tilting grill can be easily unhooked to move the heating element and clean the roof of the appliance in one simple step.		The capacity indicates the amount of usable space in the oven cavity in litres.

Benefit (TT)

Electronic control

Timely temperature management and heat uniformity

Child control lock

Thanks to the child safety lock, the microwave provides peace of mind for parents while improving overall safety in the home environment

Pizza function

Preset mode for optimal baking or heating of pizza