

MP822NPO



Product Family	Microwave
Category	Built-in
Installation type	Built-in
Installation	Under cupboard
Power supply	Electric
Cooking Method	Microwave
Control	Electronic



Aesthetics

Aesthetic Colour	Coloniale Cream	Serigraphy colour	Gold
Components finishing	Antique brass	Door	With panel
Material	Painted material	Logo	Silk screen

Program / Functions



No. of functions	1	Microwave	Yes
-------------------------	---	------------------	-----

Controls

Type of control setting	Control knobs	Control knobs	Colonial
Opening	Mechanical button	Controls colour	Cream
No. of controls	2		

Options



Timer	Electronic	Showroom demo option	Yes
Time-setting options	Start and stop	Controls Lock / Child Safety	Yes
End of cooking acoustic alarm	Yes		

Technical Features



Cavity material	Stainless steel	Total no. of door glasses	2
No. of lights	1	Safety Thermostat	Yes
Light type	Incandescent	Cooling system	Tangential
Light Power	20 W	Microwave screen protection	Yes
Ceramic base	Yes	Microwave stops when door is opened	Yes
Light when door is opened	Yes	Usable cavity space dimensions (HxWxD)	220x350x280 mm
Door opening	Side-opening	Microwave effective power	850 W

Performance / Energy Label



Usable volume	22 l	Gross volume	23 l
----------------------	------	---------------------	------

Electrical Connection

Plug	Not present	Voltage (V)	220-240 V
Nominal power	2700 W	Frequency (Hz)	50 Hz
Current	11.7 A	Power supply cable length	150 cm

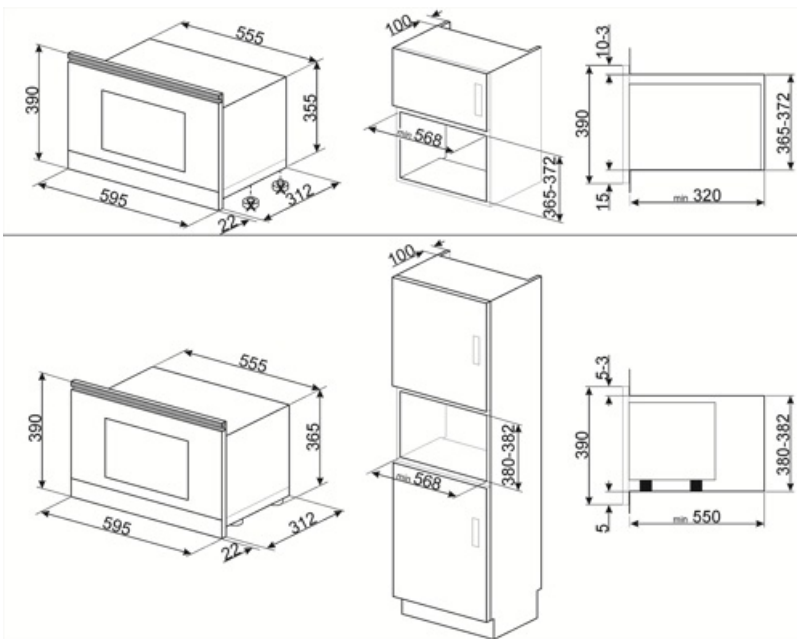







Alternative products

MP822NAO

Colour: Anthracite



Symbols glossary

- | | | | |
|--|--|---|--|
|  | Surfaceplus ceramic base: Surfaceplus ceramic base for a microwave oven - no turntable required, and the whole surface can be used for cooking. |  | Child lock: some models are fitted with a device to lock the programme/cycle so it cannot be accidentally changed. |
|  | Microwave energy shortens cooking times dramatically and produces energy savings. |  | Double glazed doors: Number of glazed doors. |
|  | Microwave: Penetrating straight into the food, microwaves cook very quickly and with considerable energy savings. Suitable for cooking without fat, they are also able to thaw and heat food without altering its original appearance and aroma. The microwave function can also be combined with conventional functions with all the resulting advantages. Ideal for all types of food. |  | The capacity indicates the amount of usable space in the oven cavity in litres. |