

OTR24XU



Product Family	Microwave
Category	Built-in
Installation type	Built-in
Power supply	AC
Cooking Method	Microwave
Control	Electronic



Aesthetics

Colour	Stainless steel/Black	Serigraphy colour	White
Material	Inox + vetro	Logo	Silk screen

Program / Functions



No. of functions	4	Microwave	Yes
Defrost by time	Yes	Other Microwave functions	Sensor cook
Defrost by weight	Yes		

Controls



Display / Clock	1 a LED	Opening	Side opening
Type of control setting	Touch control		

Options



Timer	Electronic	Stop turntable option	Yes
End of cooking acoustic alarm	Yes	Quick start option	Yes
Controls Lock / Child Safety	Yes		

Technical Features



Cavity material	Galvanized steel	Total no. of door glasses	1
No. of lights	1	Safety Thermostat	Yes
Light type	Led	Microwave screen protection	Yes
Turntable	Yes	Microwave stops when door is opened	Yes
Turntable dimensions	13 9/16 "	Usable cavity space dimensions (HxWxD)	272x388x391 mm
Light when door is opened	Yes	Microwave effective power	1000 W

Accessories Included

Glass tray	1
-------------------	---

Performance / Energy Label





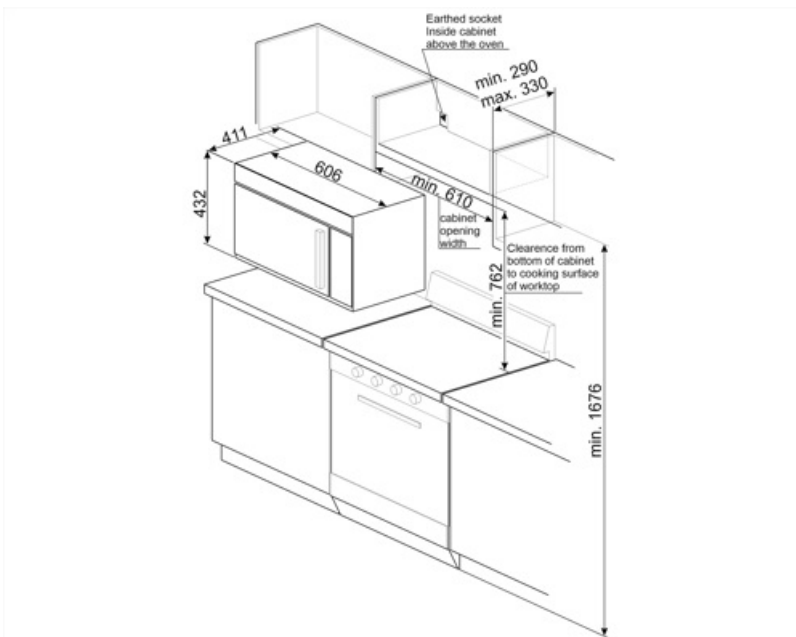

Gross volume	38 cu. ft.
---------------------	------------

Electrical Connection

Current	15 A	Frequency (Hz)	60 Hz
Voltage (V)	120 V	Power supply cable length	39 3/8 "



Symbols glossary

- | | |
|--|--|
|  <p>Child lock: some models are fitted with a device to lock the programme/cycle so it cannot be accidentally changed.</p> |  <p>Microwave energy shortens cooking times dramatically and produces energy savings.</p> |
|  <p>Defrost by time: Manual defrost function. At the end of the set duration, the function stops.</p> |  <p>Defrost by weight: Automatic defrost function. You choose the type of food to defrost from the available categories (MEAT - FISH - BREAD - DESSERTS) After entering the weight of the food, the oven automatically defines the time required for proper defrosting.</p> |
|  <p>Microwave: Penetrating straight into the food, microwaves cook very quickly and with considerable energy savings. Suitable for cooking without fat, they are also able to thaw and heat food without altering its original appearance and aroma. The microwave function can also be combined with conventional functions with all the resulting advantages. Ideal for all types of food.</p> |  <p>Side lights: Two opposing side lights increase visibility inside the oven.</p> |
|  <p>Touch controls: Easy to use touch controls allow the appliance to be programmed at the touch of a button.</p> | |