

# PM3953D



<b>Product Family</b>	Hob
<b>Built-in</b>	Traditional
<b>Dimensions</b>	90 cm
<b>Power supply</b>	Mixed
<b>Type</b>	Mixed
<b>EAN code</b>	8017709290221



## Aesthetics



<b>Aesthetics</b>	Classic
<b>Colour</b>	Black
<b>Finishing</b>	Glass
<b>Material</b>	Glass
<b>Glass Type</b>	Eclipse ceramic
<b>Glass edge</b>	Straight edge
<b>Glass on Steel</b>	Yes
<b>Series</b>	New
<b>Pan stands</b>	Cast iron
<b>Burners</b>	Smeg Contemporary
<b>Burner Material</b>	Brass
<b>Type of control setting</b>	Control knobs
<b>Slider</b>	Yes
<b>Control knobs position</b>	Front
<b>No. of controls</b>	1
<b>Controls colour</b>	Steel effect
<b>Serigraphy colour</b>	Grey

## Options



<b>Multizone Option</b>	Yes	<b>Residual time indicator</b>	Yes
<b>Flexible Zone Type</b>	MultiZone	<b>Limited Power Consumption Mode</b>	Yes advance
<b>Standard cut out</b>	482-486x839-844 mm	<b>Limited Power Consumption Mode in W</b>	2400 a 7400 - step 100 W

<b>Keep warm automatic function</b>	Yes	<b>Show Room Demo Option</b>	Yes
<b>Grill function</b>	Yes	<b>Control Lock / Child Safety</b>	Yes
<b>End cooking timer</b>	4	<b>Bridge option</b>	Yes
<b>Pause option</b>	Yes	<b>Quick start</b>	Yes
<b>Minute minder</b>	1	<b>Rapid level selection</b>	Yes
<b>End of cooking acoustic alarm</b>	Yes		

## Technical Features



Centre left - Gas - UR - 6.00 kW

Rear centre - Induction - multizone - 2.10 kW - Booster 2.50 kW - Double booster 3.00 kW - 24.0x18.0 cm

Front centre - Induction - Multizone - 2.10 kW - Booster 2.50 kW - Double booster 3.00 kW - 24.0x18.0 cm

Rear right - Induction - multizone - 2.10 kW - Booster 2.50 kW - Double booster 3.00 kW - 24.0x18.0 cm

Front right - Induction - Multizone - 2.10 kW - Booster 2.50 kW - Double booster 3.00 kW - 24.0x18.0 cm

Multizone center - Booster 3.60 kW - 38.5x23.0 cm

Multizone right - Booster 3.60 kW - 38.5x23.0 cm

<b>Automatic setting according to pan dimension</b>	Yes	<b>Automatic switch off when overheat</b>	Yes
<b>Automatic pan detection</b>	Yes	<b>Automatic switch off when overflow</b>	Yes
<b>Permanent Automatic Pot Detection with indication of the relative control</b>	Yes	<b>Residual heat indicator</b>	Yes
<b>Gas safety valves</b>	Yes	<b>Protection against accidental start up</b>	Yes
<b>Automatic Ignition</b>	Yes		

## Accessories Included

Cast iron wok support 1

## Electrical Connection

<b>Nominal power (W)</b>	7400 W	<b>Type of electric cable</b>	Single and Double phase
<b>Current</b>	33 A	<b>Frequency (Hz)</b>	50/60 Hz
<b>Voltage (V)</b>	220-240 V	<b>Power supply cable length</b>	120 cm
<b>Voltage 2 (V)</b>	380-415 V		

## Gas Connection

<b>Gas Type</b>	G20 Natural gas	<b>Other gas connections provided</b>	Conical
<b>Gas connection</b>	Cilindrical	<b>Gas connection rating (W)</b>	5900 W
<b>Other gas nozzles included</b>	G30 GPL Liquid gas		

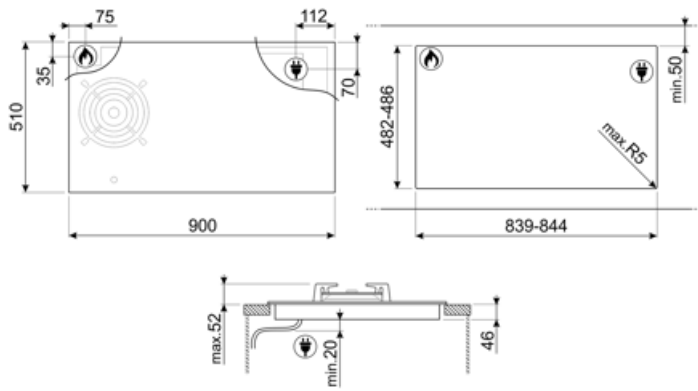

---

## Not included accessories

---



### GRILLPLATE

Universal griddle for induction, gas, ceramic and electric hobs. Non-stick surface ideal for cooking meat, cheese and vegetables. Dimensions: 410 x 240 mm.



### TPKPLATE























Universal plate for induction, gas, ceramic and electric hobs. Non-stick surface ideal for cooking fish, eggs and vegetables. Dimensions: 410 X 240 mm.



### LGCN

Connecting Strip Built-in hobs, stainless steel, 475/495 mm

## Symbols glossary

	...		Power booster: option allows the zone to work at full power when very intense cooking is necessary.
	Standard installation: Traditional installation in tabletop, suitable for any kitchen sets		Heavy duty cast iron pan stands: for maximum stability and strength.
	Child lock: some models are fitted with a device to lock the programme/cycle so it cannot be accidentally changed.		Knobs control
	The slider control panel allows you to adjust the power simply by passing your finger across the touch device.		Reinforced base: A reinforced base, developed exclusively by Smeg, consists of a steel layer fixed to the underside of the glass surface of all gas on glass hobs.
	Keep warm function: Keep warm function keeps the cooked food heated. In this mode the heating zone operates at a minimum capacity for 120 minutes and then turns off automatically.		Overheat protection: The safety system that automatically turns off the hob in case of overheating of the control unit.
	Multizone: allows several pans to be used at once, large or small, offering freedom of placement and greater flexibility		Overfill protection: The special overfill protection shuts down the stove in the presence of overflow of liquids.
	PAUSE_72dpi		Quick selection, with one touch cooking begins at the highest level, then automatically reduces after time. Ideal for dishes that require quick boiling and then continued cooking without constant control (eg beef broth).
	Quick Start function: the chosen temperature is reached faster. The heating element works at maximum power until the right temperature is reached.		Indication of residual heat: After the glass ceramic hob is switched off the residual heat indicator shows which of the heating zones still remains hot. When the temperature drops below 60 ° C, the indicator goes out.
	Time elapsed: shows how long the cooking zone has been in use.		Timer: All ceramic hobs have a timer which automatically ends cooking after a preset time.
	TWIN_ZONE_72dpi		Ultra rapid burners: Powerful ultra rapid burners offer up to 5kw of power.
	...		...
	Darkness becomes light		