

# PM6721WLDR



<b>Product Family</b>	Hob
<b>Built-in</b>	Traditional
<b>Dimensions</b>	70/75 cm
<b>Power supply</b>	Mixed
<b>Type</b>	Mixed
<b>EAN code</b>	8017709230470



## Aesthetics



<b>Aesthetics</b>	Dolce Stil Novo
<b>Colour</b>	Black
<b>Finishing</b>	Glass
<b>Material</b>	Glass
<b>Glass Type</b>	Eclipse ceramic
<b>Glass edge</b>	Straight edge
<b>Glass on Steel</b>	Yes
<b>Pan stands</b>	Cast iron
<b>Burners</b>	Smeg Contemporary
<b>Burner Material</b>	Aluminium
<b>Burner Coating</b>	Black Ceram
<b>Type of control setting</b>	Control knobs
<b>Slider</b>	Yes
<b>Control knobs position</b>	Front
<b>No. of controls</b>	2
<b>Controls colour</b>	Black
<b>Components finishing</b>	Copper
<b>Serigraphy colour</b>	Grey
<b>Alternative colours available</b>	Stainless steel

## Programs / Functions



<b>Total no. of cook zones</b>	4
<b>No. of gas cook zones</b>	2

No. of induction cook zones	2
No. of cooking zones with booster	2
No. of Flexible zones	1
Main on/off switch	Yes
Power levels	9

## Options



Multizone Option	Yes	Pause option	Yes
Flexible Zone Type	MultiZone	Minute minder	1
Standard cut out	482-486x719-724 mm	End of cooking acoustic alarm	Yes
Simmering Function	Yes	Residual time indicator	Yes
Keep warm automatic function	Yes	Show Room Demo Option	Yes
Melting/Low temperature cooking function	Yes	Control Lock / Child Safety	Yes
End cooking timer	2	Rapid level selection	Yes

## Technical Features



Front left - Gas - AUX - 1.10 kW  
 Rear left - Gas - UR - 3.30 kW  
 Rear right - Induction - Multizone - 2.10 kW - Booster 3.60 kW - 18.0x23.0 cm  
 Front right - Induction - multizone - 2.10 kW - Booster 3.60 kW - 18.0x23.0 cm  
 Multizone right - Booster 3.60 kW - 38.5x23.0 cm

Automatic setting according to pan dimension	Yes	Automatic switch off when overheat	Yes
Automatic pan detection	Yes, min 9 cm	Automatic switch off when overflow	Yes
Permanent Automatic Pot Detection with indication of the relative control	Yes	Residual heat indicator	Yes
Gas safety valves	Yes	Protection against accidental start up	Yes
Automatic Ignition	Yes		

## Accessories Included

Cast iron wok support 1

## Electrical Connection

Nominal power (W)	3700 W	Type of electric cable	Single phase
Current	16 A	Frequency (Hz)	50/60 Hz

---

Voltage (V)	220-240 V	Power supply cable length	120 cm
-------------	-----------	---------------------------	--------

## Gas Connection

---

Gas Type	G20/G25 natural gas	Other gas connections provided	Conical
Gas connection	Cilindrical	Gas connection rating (W)	4400 W
Other gas nozzles included	G30 GPL Liquid gas		

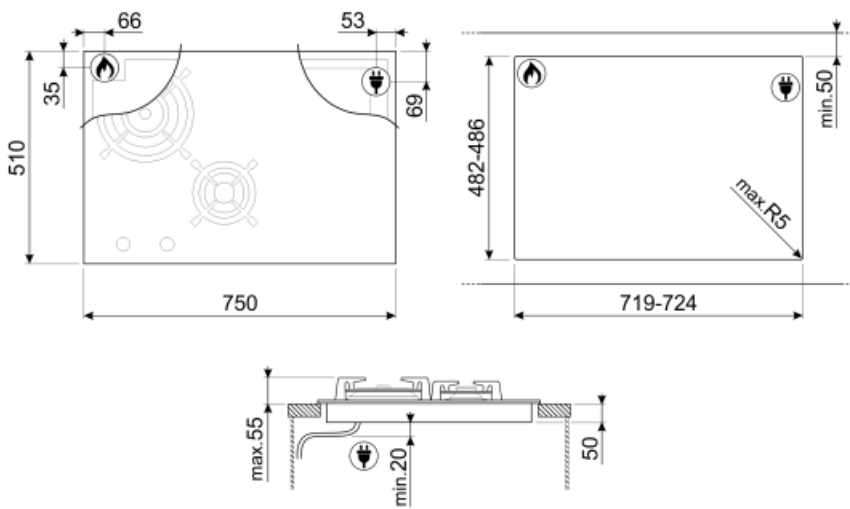

---

## Not included accessories

---

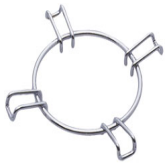

**GRW**  
Wok support



**WOKGHU**  
Cast-Iron WOK Support



**TPK**  
Stainless steel grill plate to cook  
Teppanyaki dishes



**TPKPLATE**  
Universal plate for induction, gas,  
ceramic and electric hobs. Non-stick  
surface ideal for cooking fish, eggs and  
vegetables. Dimensions: 410 X 240 mm.



### GRILLPLATE

Universal griddle for induction, gas,  
ceramic and electric hobs. Non-stick  
surface ideal for cooking meat, cheese  
and vegetables. Dimensions: 410 x  
240 mm.

























**GRM**  
Gas hobs moka support



### LGCN

Connecting Strip Built-in hobs,  
stainless steel, 475/495 mm

## Symbols glossary

	...		Power booster: option allows the zone to work at full power when very intense cooking is necessary.
	Standard installation: Traditional installation in tabletop, suitable for any kitchen sets		Heavy duty cast iron pan stands: for maximum stability and strength.
	Child lock: some models are fitted with a device to lock the programme/cycle so it cannot be accidentally changed.		Knobs control
	The slider control panel allows you to adjust the power simply by passing your finger across the touch device.		Darkness becomes light
	Reinforced base: A reinforced base, developed exclusively by Smeg, consists of a steel layer fixed to the underside of the glass surface of all gas on glass hobs.		Keep warm function: Keep warm function keeps the cooked food heated. In this mode the heating zone operates at a minimum capacity for 120 minutes and then turns off automatically.
	Overheat protection: The safety system that automatically turns off the hob in case of overheating of the control unit.		Melting function, suitable for slowly melting delicate foods such as chocolate or butter.
	Multizone: allows several pans to be used at once, large or small, offering freedom of placement and greater flexibility		Overfill protection: The special overfill protection shuts down the stove in the presence of overflow of liquids.
	PAUSE_72dpi		Quick selection, with one touch cooking begins at the highest level, then automatically reduces after time. Ideal for dishes that require quick boiling and then continued cooking without constant control (eg beef broth).
	Indication of residual heat: After the glass ceramic hob is switched off the residual heat indicator shows which of the heating zones still remains hot. When the temperature drops below 60 ° C, the indicator goes out.		Simmering function: ideal for long-cooking recipes, preventing food from boiling over or sticking to the pan.
	Time elapsed: shows how long the cooking zone has been in use.		Timer: All ceramic hobs have a timer which automatically ends cooking after a preset time.
	Ultra rapid burners: Powerful ultra rapid burners offer up to 5kw of power.		...