

PX364LSA

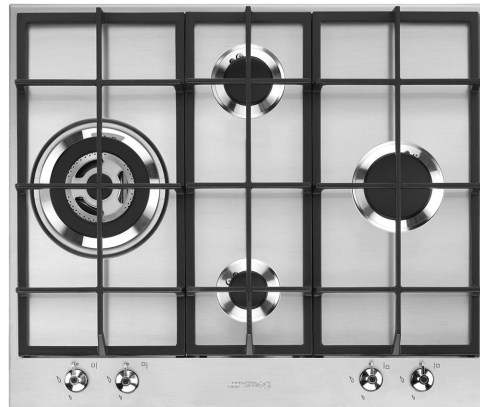

Produktgruppe	Platetopp
Type innbygging	Standard
Mål	60 cm
Strømtilførsel	Gass
Type	Gasskokeplate
EAN-kode	8017709261245



Estetisk linje



Estetikk	Classic
Serie	Ny
Farge	Rustfritt stål
Finish	Satinert
Materiale	Rustfritt stål
Type stål	Børstet
Panne stativ	Støpejern
Brennere	Smeg Contemporary
Materiale brennere	Aluminium
Type kontroll innstilling	Vridere
Kontrollknapp funksjon	Foran
Antall kontroller	4
kontroller farge	Rustfritt stål-effekt
Logo	Preget
Serigrafi farge	Sort

Program / funksjoner

Antall gasstilberedningssoner	4
Antall tilberedningssoner	4

Funksjoner



Nedfelling i benkeplate 478-482x555-560 mm

Tekniske egenskaper

UR

Venstre - Gass - URP - 3.50 kW
 Midten bak - Gass - SRD - 1.80 kW
 Midten foran - Gass - AUX - 1.10 kW
 Høyre - Gass - RP - 2.60 kW

Gassikkerhetsventiler Ja Automatisk tenning Ja

Elektrisk tilkobling

Elektrisk tilkoblingseffekt (W)	1 W	Frekvens (Hz)	50/60 Hz
Spenning (V)	220-240 V	Lengde på strømledning (cm)	120 cm
Type ledning	Enfase	Støpseltype	Nei

Gasstilkobling

Gasstype	Flytende gass G30 GPL	Andre medfølgende dyser	Bygass G110, Naturgass G20
Gasstilkobling	Sylindrisk	Måling av gassforbindelse (W)	9000 W

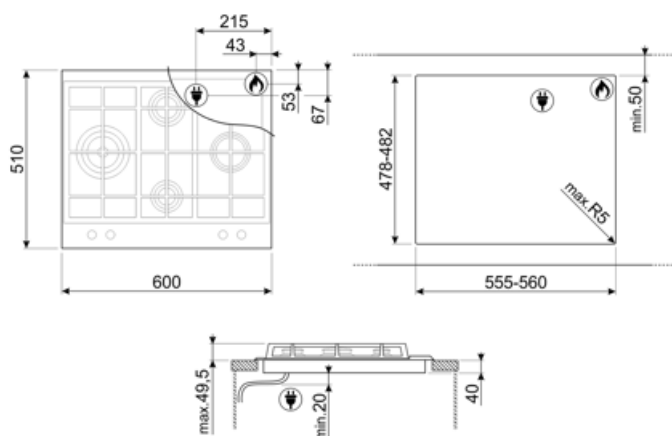

Compatible Accessories







GRW
Wok support



WOKGHU
Cast-Iron WOK Support

Symbols glossary

	Standard installasjon: Tradisjonell installasjon i benkeplate, egnet for samtlige kjøkken		Gryterister i støpejern, høy ytelse: For maksimal stabilitet og styrke.
	CUT_OUT_STANDARD_72dpi		Ultra Rapid brennere: Kraftige Ultra Rapid hurtigbrennere på opptil 5kw effekt.
	Bryterknottkontroll		