

PX375MB

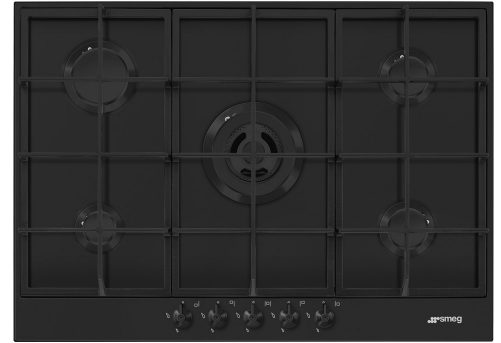

Product Family	Hob
Built-in type	Traditional
Dimensions	70/75 cm
Power supply	Gas
Type	Gas
EAN code	8017709321628



Aesthetics



Aesthetic	Classica
Colour	Preto opaco
Acabamento	Preto opaco
Material	Enamelled
Série	Nova
Pan stands	Cast iron
Pan Stand Coating	No
Burners	Smeg Contemporary
Burners Material	Alluminium
Burner Coating	Black Ceram
Type of control setting	Control knobs
Control knob position	Front
No. of controls	5
Controls colour	Preto opaco
Illuminated control knobs	No
Control knob protection	No
Serigraphy colour	Prata
Alternative colours available	No

Program / Functions

No. of gas cook zones	5
Total no. of cook zones	5

Options



Corte padrão

478-482x555-560 mm

Technical Features



Front-left - Gas - AUX - 1.10 kW

Rear-left - Gas - Rapid - 2.60 kW

Central - Gas - UR - 4.00 kW

Rear-right - Gas - Semi Rapid - 1.80 kW

Front-right - Gas - Semi Rapid - 1.80 kW

Gas safety valves	Yes	Automatic Ignition	Yes
-------------------	-----	--------------------	-----

Accessories Included

Other accessories	No
-------------------	----

Electrical Connection

Plug	No	Frequency (Hz)	50/60 Hz
Electrical connection rating (W)	1 W	Comprimento do cabo de alimentação	120 cm
Voltage (V)	220-240 V	Ficha elétrica	No
Type of electric cable	Single phase		

Gas Connection

Gas Type	G20 Natural gas	Other gas connections provided	Conical
Ligação ao gás	Ligação ao gás cilíndrica	Gas connection rating (W)	11300 W
Other gas nozzles included	G30 GPL Liquid gas		

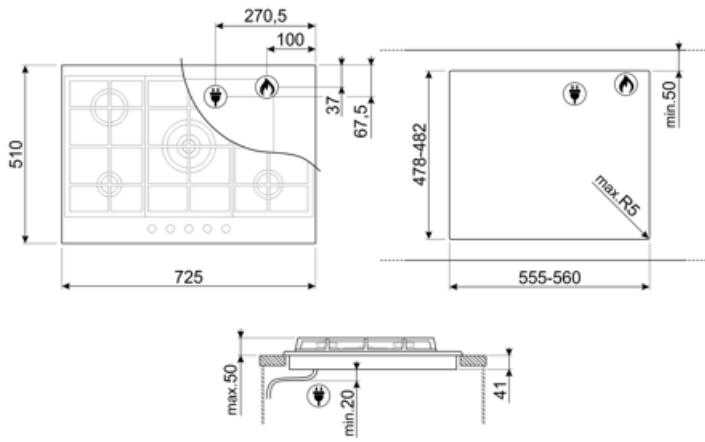

Compatible Accessories



GRW

Suporte para wok



TPK





Placa grelhadora de aço inoxidável
para cozinhar pratos Teppanyaki



WOKGHU

Suporte de ferro fundido para WOK

Symbols glossary

- | | | | |
|--|--|---|---|
|  | Instalação padrão: Instalação tradicional em tampo de mesa, adequado para qualquer conjunto de cozinha |  | Suportes de ferro fundido para serviço pesado: para máxima estabilidade e resistência. |
|  | CUT_OUT_STANDARD_72dpi |  | Queimadores ultrarrápidos: Queimadores ultrarrápidos potentes oferecem até 5kw de potência. |
|  | Controle dos botões | | |