

# RBM36RNI



<b>Product Family</b>	Refrigerator
<b>Installation</b>	Built-in
<b>Category</b>	Bottom Mount
<b>Built-in niche</b>	>200
<b>Reference width</b>	Higher than 80 cm
<b>Reference height</b>	Higher than 200 cm
<b>Sistema Total No - Frost</b>	Total
<b>Cooling type</b>	Total No Frost - Double Cooling system
<b>Defrost</b>	Automatic
<b>Hinge type</b>	Door on door
<b>Kitchen panel</b>	Not supplied
<b>Hinge position</b>	Right
<b>EAN code</b>	8017709358013



## Aesthetics

<b>Aesthetic</b>	Universale	<b>Logo</b>	Applied
<b>Handle</b>	Not included	<b>Display</b>	TFT
<b>Logo colour</b>	Stainless Steel	<b>Display position</b>	Interno (sul Top)
<b>Side material</b>	Steel		

## Refrigerator compartment features



<b>Number of compartments</b>	2	<b>Crisper Cover</b>	Yes
<b>Compartment types</b>	Low temperature compartment, Fruit and vegetable compartment	<b>Type of crisper/vegetable drawers cover</b>	Glass
<b>No. of adjustable shelves</b>	3	<b>Low temperature compartment</b>	Yes
<b>Number of fruit and vegetables drawers</b>	1	<b>Internal light in fridge</b>	Yes
<b>Shelves material</b>	Glass	<b>Type of internal light (fridge)</b>	LED
<b>Type of crisper/vegetable drawers cover</b>	On sliding rails		

## Refrigerator Inner Door

<b>Number of adjustable door shelves</b>	3
--	---

## Other Refrigerator features



MultiFlow Yes

## Freezer compartment features

Number of drawers 1

## Other technical features

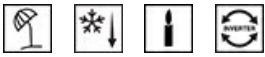

Functions display

Holiday, Fast freezing, Fast cooling, Temperature alarm, Sabbath

Temperature Alarm

Yes

Type of temperature control

Electronic

No. of compressors

2

Refrigerant gas type

HFO

Type of compressor

Inverter

## Performance / Energy Label - Reg. 2019

Climate class SN, N, ST, T

## Electrical Connection

Current	1,5 A	Power supply cable length	200 cm
Voltage (V)	220-240 V	Plug	(F;E) Schuko
Frequency (Hz)	50/60 Hz		

## Logistic Information



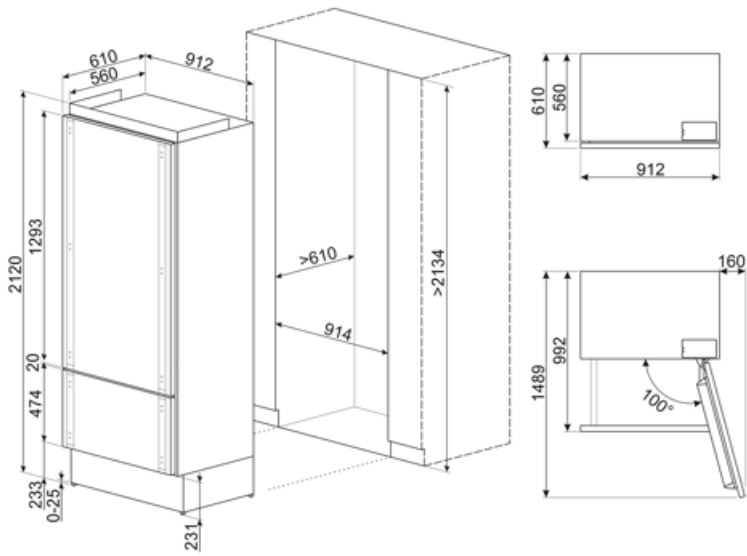



Width	899 mm	Depth of the built-in niche	610 mm
Width of the built-in niche	914 mm	Height	2050 mm
Depth without handle	610 mm	Height of the built-in niche	2134 mm



---

## Symbols glossary

---

- |  |  |   |   |
|--|--|---|---|
|  | The automatic defrost system works by automatically defrosting at regular intervals eliminating the need to defrost altogether.                          |  | Fast freezing: The fast freezing function brings the temperature of the compartment down when activated a few hours prior to usage. |
|  | Power saving mode: The power saving mode allows you to disable the refrigerator and keep the freezer working.  |  | LED interior lighting: is a more energy efficient and long lasting way of illuminating the interior of the appliance.               |
|  | Smeg's evolution towards more intelligent and eco-friendly models has led to the choice of Inverter technology, which significantly reduces consumption. |  | Multiflow Cooling System: the Multiflow ventilation system allows an even distribution of cool air around the fridge cabinet.       |
|  | SABBATH: function that allows to cook food respecting Judaism's day of rest provisions.  |   |   |