

RC18XDNC



| | |
|--------------------|-----------------------|
| Product familie | Koelkast |
| Installatie | Vrijstaand |
| Categorie | Koel-vriescombinatie |
| Referentie breedte | Tot 60 cm cm |
| Referentie hoogte | 160 - 200 cm cm |
| No Frost systeem | Ja |
| Type koelen | No Frost |
| Ontdooien | Automatisch ontdooien |
| Type scharnier | Standaard |
| Positie scharnier | Rechts |
| Deur omkeerbaar | Ja |
| EAN-code | 8017709343248 |



Design



| | | | |
|----------------|--------------|---------------------|--------------------|
| Design | Universeel | Materiaal zijwanden | Staal |
| Kleur | Inox Look | Kleur zijkanten | Zilver |
| Materiaal deur | Inox look | Logo | Geassembleerd |
| Handgreep | Geïntegreerd | Display | LED |
| Type handgreep | Vast | Positie display | Esterno (su porta) |
| Kleur logo | Chroom | | |

Uitrusting koelkast



| | | | |
|------------------------------------|--|------------------------------------|------|
| Number of compartments | 2 | Flessenhouder | Ja |
| Compartment types | Low temperature compartment, Fruit and vegetable compartment | Type afdekplaat groente-/fruitlade | Glas |
| Aantal verstelbare leggers | 2 | Aantal lampen | 1 |
| Aantal groente-/fruitlades | 1 | Convertible temperature drawer | No |
| Shelves material | Glas | Low temperature compartment | Ja |
| Type afdekplaat groente-/fruitlade | Op telescopische geleiders | Binnenverlichting koelkast | Ja |
| Afdekplaat groentenlade | Ja | Type binnenverlichting koelkast | LED |

Binnendeur koelkast

Aantal verstelbare
binnendeurcompartimenten 2

Aantal flessenhouders 1

Overige features koelkast



Humidity Control Yes, manual
Accessoires Eierhouder

MultiFlow Ja

Uitrusting vriezer

Aantal lades 3

Overige features vriezer

Accessoires 1 ijsblokeshouder

Overige technische eigenschappen



| | |
|--------------------------|------------------------|
| Display functies | Snel-vriesfunctie, ECO |
| Alarm open deur | Ja |
| Temperature Alarm | Ja |
| Type temperatuurcontrole | Elektronisch |
| Aantal compressoren | 1 |
| Type koelgas | R600a |
| Type compressor | Variabele toeren |
| Schuimmiddel | Cyclopentaan |

Prestaties/Energie label - Reg. 2019



| | | | |
|---|--------------|---------------------------------|------------------|
| Annual energy consumption | 155 kWh/jaar | Geluidsniveau | 35 dB(A) re 1 pW |
| Energie-efficiëntieklasse | C | Conserveringsduur zonder stroom | 10 h |
| Emissieklasse voor akoestisch luchtgeluid | B | 4 star - Freezing capacity | 11,0 kg/24h |
| Totaal netto volume | 300 l | Klimaatklasse | SN, N, ST, T |
| Netto inhoud vriesgedeelte | 96 l | EEL | 64 % |
| Netto inhoud koelgedeeltes | 204 l | | |

Elektrische aansluiting

Frequentie (Hz) 50 Hz







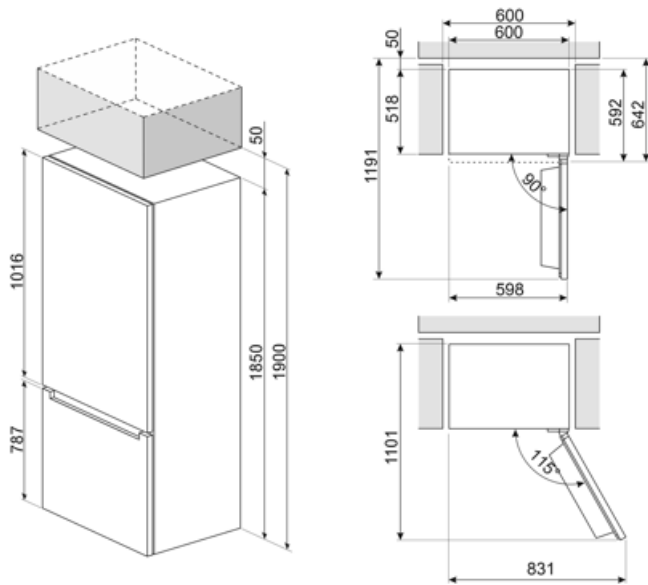

| | | | |
|-------------------------|-----------|----------------------------|------------------------|
| Nominale aansluitwaarde | 200 W | Lengte stroomkabel Stekker | 200 cm (F;E) Schuko |
| Stroom (A) | 0,9 A | | |
| Spanning (V) | 220-240 V | | |

Logistieke informatie

| | | | |
|---------------------------------|--------|----------------|---------|
| Breedte product (mm) | 600 mm | Maximum hoogte | 1850 mm |
| Diepte zonder handvat en spacer | 592 mm | | |



Symbols glossary

- | | | | |
|--|--|---|--|
|  | The automatic defrost system works by automatically defrosting at regular intervals eliminating the need to defrost altogether. |  | LED display: to show programmes, functions and options selected and the time to the end of the cycle. |
|  | Economical mode: Analyzes fridge functioning during the activation and optimizes the operating cycle in order to reduce power consumption. |  | Fast freezing: The fast freezing function brings the temperature of the compartment down when activated a few hours prior to usage. |
|  | LED interior lighting: is a more energy efficient and long lasting way of illuminating the interior of the appliance. |  | De evolutie van Smeg vaatwassers naar meer intelligente en milieuvriendelijke modellen heeft ertoe geleid om de inverter technologie te gebruiken, die een significante energie- en geluidsbesparing met zich meebrengt. |
|  | Multiflow Cooling System: the Multiflow ventilation system allows an even distribution of cool air around the fridge cabinet. |  | Energie-efficiëntieklasse |