

## RC18XDND



|                                  |                |
|----------------------------------|----------------|
| Product Family                   | Refrigerator   |
| Installation                     | Free Standing  |
| Category                         | Bottom Mount   |
| Reference width                  | Until 60       |
| Reference height                 | 160 - 200      |
| Cooling type                     | Total No Frost |
| Defrost                          | Automatic      |
| Hinge type                       | Standard       |
| Door opening flush with the wall | No             |
| Slot-in                          | No             |
| Hinge position                   | Right          |
| Reversible door                  | Yes            |
| EAN code                         | 8017709343231  |



## Aesthetics



|                                     |              |                 |                    |
|-------------------------------------|--------------|-----------------|--------------------|
| Aesthetic                           | Universal    | Side colour     | Silver             |
| Colour                              | Aspecto inox | Logotipo        | Logotipo aplicado  |
| Material                            | Steel Effect | Display         | LED                |
| Handle kit to be ordered separately | No           | Mostrar porções | Externo (na porta) |
| Handle                              | Integrated   | Dispenser       | No                 |
| Handle type                         | Fixed        | Water Filter    | No                 |
| Logo colour                         | Chrome       | HomeBar         | No                 |
| Side material                       | Steel        |                 |                    |

## Refrigerator compartment features



|   |                  |   |       |
|---|------------------|---|-------|
| No. of adjustable shelves               | 2                | Type of crisper/vegetable drawers cover | Glass |
| Number of fruit and vegetables drawers  | 1                | Nº de lâmpadas                          | 1     |
| Type of adjustable shelves              | Glass            | Life Plus zone-0°C                      | No    |
| Type of crisper/vegetable drawers cover | On sliding rails | Compartimento baixa temperatura         | Yes   |
| Crisper Cover                           | Yes              | Internal light in fridge                | Yes   |
| Bottle shelf                            | Yes              | Type of internal light (fridge)         | LED   |

## Refrigerator Inner Door

Number of adjustable door shelves 2

Adjustable door shelves with wire support No

No. of bottle shelves 1

Bottle shelves with wire support No

## Other Refrigerator features



Accessories Egg tray

Natural Plus Blu Light No

MultiFlow Yes

Fan No

Ionizer No

Tecnologia de titânio No

Filtro de odor antibacteriano No

Zona de cuidados biológicos No

## Freezer compartment features

Number of drawers 3

Internal light in freezer No

## Freezer Inner Door

Pizza box No

## Other Freezer features

Accessories 1 ice box

Manual ice maker No

Ice maker No

Fast freezing compartment No

Ice tray shelf No

## Other technical features



Functions display

MultiZone

Ligação à rede de água

Door open alarm

Temperature Alarm

Type of temperature control

No. of compressors

Refrigerant gas type

Type of compressor

Espuma expansiva de isolamento

Fast freezing, ECO

No

No

Yes

Yes

Electronic

1

R600a

Inverter

Ciclopentano

## Etiqueta de Desempenho / Energia - Reg. 2019









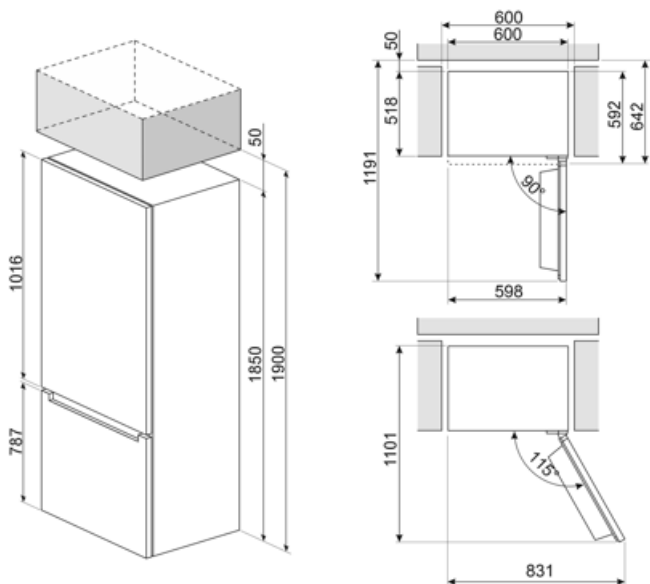

|   |           |  |                  |
|---|-----------|--|------------------|
| <b>Consumo de energia anual</b>   | 194 kWh/a | <b>Airborne acoustical noise emissions</b>           | 35 dB(A) re 1 pW |
| <b>Classe de eficiência energética</b>  | D         | <b>Autonomia de conservação sem energia elétrica</b> | 10 h             |
| <b>Classe de emissão de ruído acústico aerotransportado</b>   | B         | <b>4 estrelas - Capacidade de congelamento</b>       | 10.0 Kg/24h      |
| <b>Volume líquido total</b>   | 300 l     | <b>Classe climática</b>                              | SN, N, ST, T     |
| <b>Soma dos volumes do(s) compartimento(s) congelado(s)</b>   | 96 l      | <b>EI</b>  | 80 %             |
| <b>Soma dos volumes do(s) compartimento(s) refrigerado(s) e do(s) compartimento(s) não congelado(s)</b> | 204 l     |  |                  |

## Electrical Connection

|                                     |              |                                  |           |
|-------------------------------------|--------------|----------------------------------|-----------|
| <b>Plug</b>                         | (F;E) Schuko | <b>Voltage (V)</b>               | 220-240 V |
| <b>Electrical connection rating</b> | 200 W        | <b>Frequency (Hz)</b>            | 50 Hz     |
| <b>Current</b>                      | 0.9 A        | <b>Power supply cable length</b> | 200 cm    |



## Symbols glossary

|  |   |   |  |
|--|---|---|--|
|  | O sistema de descongelamento automático funciona descongelando automaticamente em intervalos regulares, eliminando a necessidade de descongelar completamente.  |  | Classe de eficiência energética D  |
|  | Display LED: para mostrar os programas, funções e opções selecionadas e o tempo até ao final do ciclo.  |  | Modo económico: Analisa o funcionamento da geladeira durante a ativação e otimiza o ciclo de funcionamento, a fim de reduzir o consumo de energia. |
|  | CONGELAMENTO RÁPIDO: A função de congelamento rápido reduz a temperatura do compartimento quando ativado algumas horas antes do uso.  |  | Iluminação interior LED: é uma forma mais eficiente em termos energéticos e duradoura de iluminar o interior do aparelho.                          |
|  | Tecnologia do inversor: A evolução dos secadores Smeg para modelos mais inteligentes e ambientalmente sustentáveis levou à escolha do uso da tecnologia do inversor com bombas de calor, o que reduz significativamente o consumo de energia. |  | Ar mais: mantém a comida mais fresca por mais tempo.   |

---

## Benefit (TT)

---

### **No-Frost system**

The No Frost system prevents the formation of ice and contributes to better preservation of food in the refrigerator

### **Plastic multiflow system**

The Multiflow system ensures even distribution of cold air inside the refrigerator

### **Refrigerant gas R600a**

Environmentally friendly R600a refrigerant gas contributes to rapid cooling with lower energy consumption

### **Reversible door**

Reversible door ensures flexible installation and space optimisation

### **Refrigerator Internal lighting**

Interior lighting for perfect visibility of shelves in the refrigerator compartment

### **Fruit and vegetable drawer**

The fruit and vegetable drawer ensures the best storage conditions for fresh food, avoiding any contamination

### **Inverter compressor**

Inverter compressor reduces noise and vibration levels for a quiet and comfortable kitchen environment

Inverter compressor technology offers significant advantages for refrigeration systems, improving both performance and efficiency. Better temperature control ensures a more stable and constant indoor environment, preserving the freshness of food. This technology also results in reduced energy consumption, as the compressor adjusts its speed according to cooling needs.

### **External display**

External display for simple and intuitive control with quick access to information