

RC20KDND



Product Family	Refrigerator
Installation	Free Standing
Category	Bottom Mount
Reference width	Until 60 cm
Reference height	160 - 200 cm
Sistema Total No - Frost	Yes
Cooling type	Total No Frost
Defrost	Automatic
Hinge type	Standard
Handle kit to be ordered separately	No
Door opening flush with the wall	No
Slot-in	No
Hinge position	Right
Reversible door	Yes
EAN code	8017709344757



Aesthetics



Aesthetic	Universal	Side colour	Black
Colour	Black Inox Look	Logotipo	Logotipo aplicado
Material	Metal sheet	Display	LED
Handle	Integrated	Mostrar porções	Externo (na porta)
Handle type	Fixed	Dispenser	No
Logo colour	Chrome	Water Filter	No
Side material	Steel	HomeBar	No

Refrigerator compartment features



Number of compartments	2	Bottle shelf	Yes
Compartment types	Low temperature compartment, Fruit and vegetable compartment	Type of crisper/vegetable drawers cover	Glass
No. of adjustable shelves	3	Nº de lâmpadas	1
Number of fruit and vegetables drawers	1	Life Plus zone-0°C	No
Shelves material	Glass	Compartimento baixa temperatura	Yes
Type of crisper/vegetable drawers cover	On sliding rails	Internal light in fridge	Yes
		Type of internal light (fridge)	LED

Crisper Cover Yes

Refrigerator Inner Door

Number of adjustable door shelves	3	No. of bottle shelves	1
Adjustable door shelves with wire support	No	Bottle shelves with wire support	No

Other Refrigerator features



Humidity Control	Yes, manual	Ionizer	No
Accessories	Bottle holder, Egg tray	Tecnologia de titânio	No
Natural Plus Blu Light	No	Filtro de odor antibacteriano	No
MultiFlow	Yes	Zona de cuidados biológicos	No
Fan	No		

Freezer compartment features

Number of drawers	3	Internal light in freezer	No
-------------------	---	---------------------------	----

Freezer Inner Door

Pizza box No

Other Freezer features

Accessories	1 ice box	Fast freezing compartment	No
Ice maker	No	Ice tray shelf	No

Other technical features



Functions display	Fast freezing, ECO
MultiZone	No
Ligação à rede de água	No
Door open alarm	Yes
Temperature Alarm	Yes
Type of temperature control	Electronic
No. of compressors	1
Refrigerant gas type	R600a
Type of compressor	Inverter

Etiqueta de Desempenho / Energia - Reg. 2019

			
Consumo de energia anual	197 kWh/a	Airborne acoustical noise emissions	35 dB(A) re 1 pW
Classe de eficiência energética	D	Autonomia de conservação sem energia elétrica	10 h
Classe de emissão de ruído acústico aerotransportado	B	4 estrelas - Capacidade de congelamento	10,0 kg/24h
Volume líquido total	331 l	Classe climática	SN, N, ST, T
Soma dos volumes do(s) compartimento(s) congelado(s)	96 l	EEl	80 %
Soma dos volumes do(s) compartimento(s) refrigerado(s) e do(s) compartimento(s) não congelado(s)	235 l		

Electrical Connection

Electrical connection rating	200 W	Frequency (Hz)	50 Hz
Current	0,9 A	Power supply cable length	200 cm
Voltage (V)	220-240 V	Plug	(F;E) Schuko

Logistic Information

Width	600 mm	Height	2000 mm
Depth without handle	592 mm		

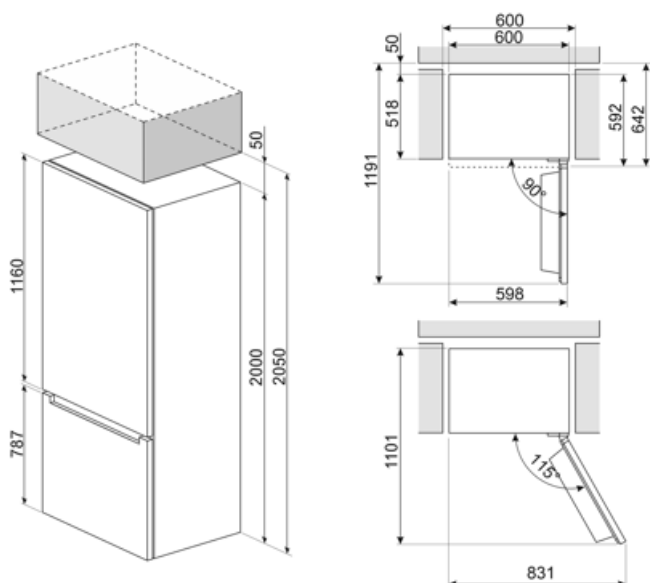









Alternative products



RC20XDND

Hinge position: Right
Inox Look

Symbols glossary

- | | | | |
|--|--|---|---|
|  | O sistema de descongelamento automático funciona descongelando automaticamente em intervalos regulares, eliminando a necessidade de descongelar completamente. |  | Display LED: para mostrar os programas, funções e opções selecionadas e o tempo até ao final do ciclo. |
|  | Modo económico: Analisa o funcionamento da geladeira durante a ativação e otimiza o ciclo de funcionamento, a fim de reduzir o consumo de energia. |  | CONGELAMENTO RÁPIDO: A função de congelamento rápido reduz a temperatura do compartimento quando ativado algumas horas antes do uso. |
|  | Iluminação interior LED: é uma forma mais eficiente em termos energéticos e duradoura de iluminar o interior do aparelho. |  | Tecnologia do inversor: A evolução dos secadores Smeg para modelos mais inteligentes e ambientalmente sustentáveis levou à escolha do uso da tecnologia do inversor com bombas de calor, o que reduz significativamente o consumo de energia. |
|  | Ar mais: mantém a comida mais fresca por mais tempo. |  | Classe de eficiência energética D |