

RC20WDNE



Product familie	Koelkast
Installatie	Vrijstaand
Categorie	Koel-vriescombinatie
Referentie breedte	Tot 60 cm cm
Referentie hoogte	160 - 200 cm cm
No Frost systeem	Ja
Type koelen	No Frost
Ontdooien	Automatisch ontdooien
Type scharnier	Standaard
Positie scharnier	Rechts
Deur omkeerbaar	Ja
EAN-code	8017709343408



Design



Design	Universeel	Materiaal zijwanden	Staal
Kleur	Wit	Kleur zijkanten	Wit
Materiaal deur	Inox look	Logo	Geassembleerd
Handgreep	Geïntegreerd	Display	LED
Type handgreep	Vast	Positie display	Esterno (su porta)
Kleur logo	Chroom		

Uitrusting koelkast



Number of compartments	2	Flessenhouder	Ja
Compartment types	Low temperature compartment, Fruit and vegetable compartment	Type afdekplaat groente-/fruitlade	Glas
Aantal verstelbare leggers	3	Convertible temperature drawer	No
Aantal groente-/fruitlades	1	Low temperature compartment	Ja
Shelves material	Glas	Binnenverlichting koelkast	Ja
Type afdekplaat groente-/fruitlade	Op telescopische geleiders	Type binnenverlichting koelkast	LED
Afdekplaat groentenlade	Ja		

Binnendeur koelkast

Aantal verstelbare
binnendeurcompartimenten 3

Aantal flessenhouders 1

Overige features koelkast



Accessoires

Flessenblokkering,
Eierhouder

MultiFlow

Ja

Uitrusting vriezer

Aantal lades 3

Overige features vriezer

Accessoires

1 ijsblokjeshouder

Overige technische eigenschappen



Display functies

Snel-vriesfunctie, ECO

Alarm open deur

Ja

Temperature Alarm

Ja

Type temperatuurcontrole

Elektronisch

Aantal compressoren

1

Type koelgas

R600a

Type compressor

Standaard

Schuimmiddel

Cyclopentaan

Prestaties/Energie label - Reg. 2019



Annual energy
consumption 246 kWh/jaar

Geluidsniveau 38 dB(A) re 1 pW

Energie-efficiëntieklasse E

Conserveringsduur
zonder stroom 10 h

Emissieklasse voor
akoestisch luchtgeluid C

4 star - Freezing
capacity 9.0 kg/24h

Totaal netto volume 331 l

Klimaatklasse SN, N, ST, T

Netto inhoud
vriesgedeelte 96 l

EEl 100 %

Netto inhoud
koelgedeeltes 235 l

Elektrische aansluiting

Frequentie (Hz)

50 Hz

Nominale aansluitwaarde	70 W	Lengte stroomkabel Stekker	200 cm (F;E) Schuko
Stroom (A)	10 A		
Spanning (V)	220-240 V		

Logistieke informatie

Breedte product (mm)	600 mm	Maximum hoogte	2000 mm
Diepte zonder handvat en spacer	592 mm	Product breedte met maximale deuropening	600 mm

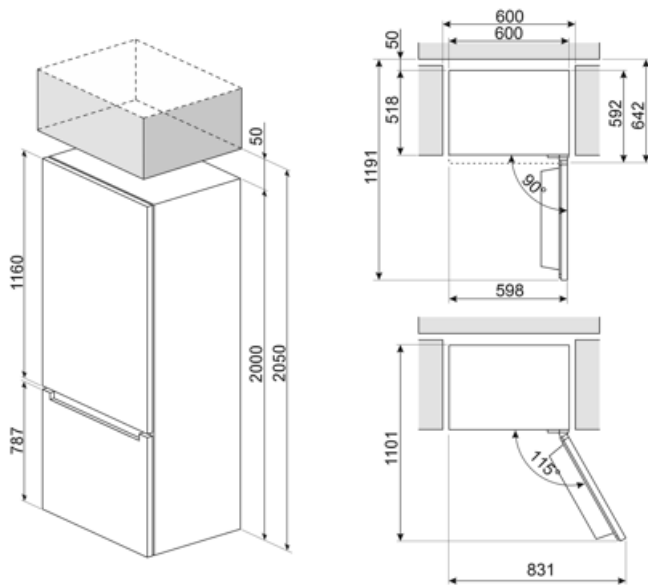







Alternative products



RC20XDNE

Positie scharnier: Rechts
Inox Look

Symbols glossary

- | | | | |
|--|---|---|--|
|  | The automatic defrost system works by automatically defrosting at regular intervals eliminating the need to defrost altogether. |  | Energie-efficiëntieklasse |
|  | LED display: to show programmes, functions and options selected and the time to the end of the cycle. |  | Economical mode: Analyzes fridge functioning during the activation and optimizes the operating cycle in order to reduce power consumption. |
|  | Fast freezing: The fast freezing function brings the temperature of the compartment down when activated a few hours prior to usage. |  | LED interior lighting: is a more energy efficient and long lasting way of illuminating the interior of the appliance. |
|  | Multiflow Cooling System: the Multiflow ventilation system allows an even distribution of cool air around the fridge cabinet. | | |