

RC20WNE



Product Family	Refrigerator
Installation	Free Standing
Category	Bottom Mount
Reference width	Until 60
Reference height	160 - 200
Cooling type	Total No Frost
Defrost	Automatic
Hinge type	Standard
Door opening flush with the wall	No
Slot-in	No
Hinge position	Right
Reversible door	Yes
EAN code	8017709343392



Aesthetics



Aesthetic	Universal	Side colour	White
Colour	White	Logotipo	Logotipo aplicado
Material	Steel Effect	Display	LED
Handle kit to be ordered separately	No	Mostrar porções	Interno (no Topo)
Handle	Integrated	Dispenser	No
Handle type	Fixed	Water Filter	No
Logo colour	Chrome	HomeBar	No
Side material	Steel		

Refrigerator compartment features



No. of adjustable shelves	4	N° de lâmpadas	1
Number of fruit and vegetables drawers	1	Life Plus zone-0°C	No
Type of adjustable shelves	Glass	Convertible temperature drawer	No
Type of crisper/vegetable drawers cover	Standard	Compartimento baixa temperatura	No
Crisper Cover	Yes	Internal light in fridge	Yes
Bottle shelf	No	Type of internal light (fridge)	LED

Type of crisper/vegetable drawers cover Glass

Refrigerator Inner Door

Number of adjustable door shelves	3	No. of bottle shelves	1
Adjustable door shelves with wire support	No	Bottle shelves with wire support	No

Other Refrigerator features



Accessories	Bottle holder, Egg tray	Ionizer	No
Natural Plus Blu Light	No	Tecnologia de titânio	No
MultiFlow	Yes	Filtro de odor antibacteriano	No
Fan	No	Zona de cuidados biológicos	No

Freezer compartment features

Number of drawers	3	Internal light in freezer	No
-------------------	---	---------------------------	----

Freezer Inner Door

Pizza box	No
-----------	----

Other Freezer features

Accessories	1 ice box	Fast freezing compartment	No
Manual ice maker	No	Ice tray shelf	No
Ice maker	No		

Other technical features



Functions display	Fast freezing, ECO
MultiZone	No
Ligação à rede de água	No
Door open alarm	Yes
Temperature Alarm	Yes
Type of temperature control	Electronic
No. of compressors	1
Refrigerant gas type	R600a

Type of compressor
Espuma expansiva de isolamento

Standard
Ciclopentano

Etiqueta de Desempenho / Energia - Reg. 2019





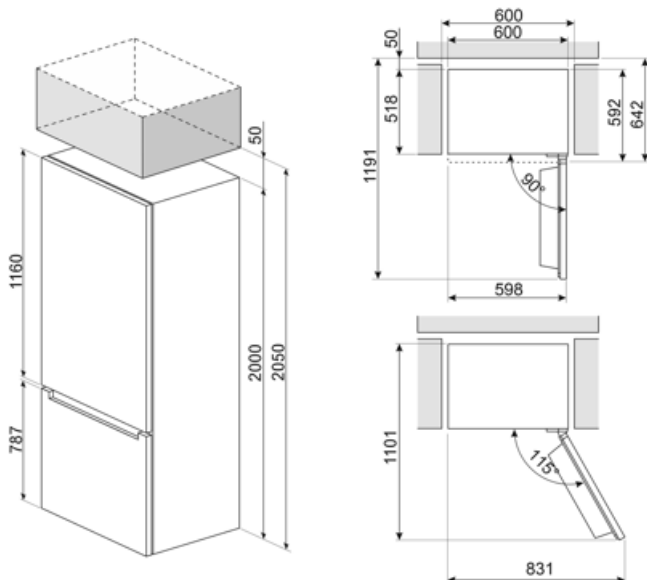

			
Consumo de energia anual	246 kWh/a	Airborne acoustical noise emissions	38 dB(A) re 1 pW
Classe de eficiência energética	E	Autonomia de conservação sem energia elétrica	10.00 h
Classe de emissão de ruído acústico aerotransportado	C	4 estrelas - Capacidade de congelamento	9.0 Kg/24h
Volume líquido total	331 l	Classe climática	SN, N, ST, T
Soma dos volumes do(s) compartimento(s) congelado(s)	96 l	EI	100 %
Soma dos volumes do(s) compartimento(s) refrigerado(s) e do(s) compartimento(s) não congelado(s)	235 l		

Electrical Connection

Plug	(F;E) Schuko	Voltage (V)	220-240 V
Electrical connection rating	200 W	Frequency (Hz)	50 Hz
Current	0,9 A	Power supply cable length	200 cm



Symbols glossary

- | | | | |
|--|--|---|--|
|  | O sistema de descongelamento automático funciona descongelando automaticamente em intervalos regulares, eliminando a necessidade de descongelar completamente. |  | Display LED: para mostrar os programas, funções e opções selecionadas e o tempo até ao final do ciclo. |
|  | Modo económico: Analisa o funcionamento da geladeira durante a ativação e otimiza o ciclo de funcionamento, a fim de reduzir o consumo de energia. |  | CONGELAMENTO RÁPIDO: A função de congelamento rápido reduz a temperatura do compartimento quando ativado algumas horas antes do uso. |
|  | Iluminação interior LED: é uma forma mais eficiente em termos energéticos e duradoura de iluminar o interior do aparelho. |  | Ar mais: mantém a comida mais fresca por mais tempo. |
|  | Classe de eficiência energética E. | | |

Benefit (TT)

No-Frost system

The No Frost system prevents the formation of ice and contributes to better preservation of food in the refrigerator

Plastic multiflow system

The Multiflow system ensures even distribution of cold air inside the refrigerator

Refrigerant gas R600a

Environmentally friendly R600a refrigerant gas contributes to rapid cooling with lower energy consumption

Reversible door

Reversible door ensures flexible installation and space optimisation

Refrigerator Internal lighting

Interior lighting for perfect visibility of shelves in the refrigerator compartment

Fruit and vegetable drawer

The fruit and vegetable drawer ensures the best storage conditions for fresh food, avoiding any contamination

Internal display

Internal display for targeted temperature control and a clean, minimalist design