

RC20XDNC



Product Family	Refrigerator
Installation	Free Standing
Category	Bottom Mount
Reference width	Until 60
Reference height	160 - 200
Cooling type	Total No Frost
Defrost	Automatic
Hinge type	Standard
Door opening flush with the wall	No
Slot-in	No
Hinge position	Right
Reversible door	Yes
EAN code	8017709343309



Aesthetics



Aesthetic	Universal	Side colour	Silver
Colour	Aspecto inox	Logotipo	Logotipo aplicado
Material	Steel Effect	Display	LED
Handle kit to be ordered separately	No	Mostrar porções	Externo (na porta)
Handle	Integrated	Dispenser	No
Handle type	Fixed	Water Filter	No
Logo colour	Chrome	HomeBar	No
Side material	Steel		

Refrigerator compartment features



No. of adjustable shelves	3	Type of crisper/vegetable drawers cover	Glass
Number of fruit and vegetables drawers	1	N° de lâmpadas	1
Type of adjustable shelves	Glass	Life Plus zone-0°C	No
Type of crisper/vegetable drawers cover	On sliding rails	Compartimento baixa temperatura	Yes
Crisper Cover	Yes	Internal light in fridge	Yes
Bottle shelf	Yes	Type of internal light (fridge)	LED

Refrigerator Inner Door

Number of adjustable door shelves 3

Adjustable door shelves with wire support No

No. of bottle shelves 1

Bottle shelves with wire support No

Other Refrigerator features



Accessories Bottle holder, Egg tray

Natural Plus Blu Light No

MultiFlow Yes

Fan No

Ionizer No

Tecnologia de titânio No

Filtro de odor antibacteriano No

Zona de cuidados biológicos No

Freezer compartment features

Number of drawers 3

Internal light in freezer No

Freezer Inner Door

Pizza box No

Other Freezer features

Accessories 1 ice box

Manual ice maker No

Ice maker No

Fast freezing compartment No

Ice tray shelf No

Other technical features



Functions display

MultiZone

Ligação à rede de água

Door open alarm

Temperature Alarm

Type of temperature control

No. of compressors

Refrigerant gas type

Type of compressor

Espuma expansiva de isolamento

Fast freezing, ECO

No

No

Yes

Yes

Electronic

1

R600a

Inverter

Ciclopentano

Etiqueta de Desempenho / Energia - Reg. 2019







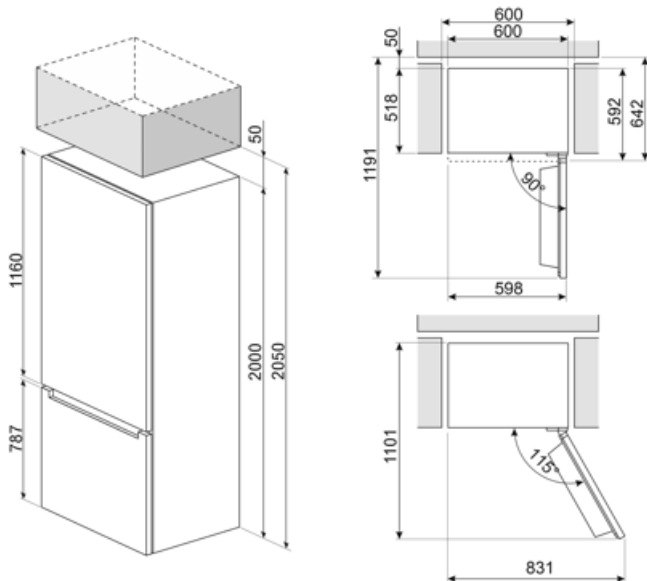

Consumo de energia anual	158 kWh/a	Airborne acoustical noise emissions	35 dB(A) re 1 pW
Classe de eficiência energética	C	Autonomia de conservação sem energia elétrica	10 h
Classe de emissão de ruído acústico aerotransportado	B	4 estrelas - Capacidade de congelamento	10.0 Kg/24h
Volume líquido total	331 l	Classe climática	SN, N, ST, T
Soma dos volumes do(s) compartimento(s) congelado(s)	96 l	EI	64 %
Soma dos volumes do(s) compartimento(s) refrigerado(s) e do(s) compartimento(s) não congelado(s)	235 l		

Electrical Connection

Plug	(F;E) Schuko	Voltage (V)	220-240 V
Electrical connection rating	200 W	Frequency (Hz)	50 Hz
Current	0,9 A	Power supply cable length	200 cm



Symbols glossary

- | | | | |
|--|--|---|---|
|  | O sistema de descongelamento automático funciona descongelando automaticamente em intervalos regulares, eliminando a necessidade de descongelar completamente. |  | Display LED: para mostrar os programas, funções e opções selecionadas e o tempo até ao final do ciclo. |
|  | Modo económico: Analisa o funcionamento da geladeira durante a ativação e otimiza o ciclo de funcionamento, a fim de reduzir o consumo de energia. |  | CONGELAMENTO RÁPIDO: A função de congelamento rápido reduz a temperatura do compartimento quando ativado algumas horas antes do uso. |
|  | Iluminação interior LED: é uma forma mais eficiente em termos energéticos e duradoura de iluminar o interior do aparelho. |  | Tecnologia do inversor: A evolução dos secadores Smeg para modelos mais inteligentes e ambientalmente sustentáveis levou à escolha do uso da tecnologia do inversor com bombas de calor, o que reduz significativamente o consumo de energia. |
|  | Ar mais: mantém a comida mais fresca por mais tempo. |  | Classe de eficiência energética C |

Benefit (TT)

No-Frost system

The No Frost system prevents the formation of ice and contributes to better preservation of food in the refrigerator

Plastic multiflow system

The Multiflow system ensures even distribution of cold air inside the refrigerator

Refrigerant gas R600a

Environmentally friendly R600a refrigerant gas contributes to rapid cooling with lower energy consumption

Reversible door

Reversible door ensures flexible installation and space optimisation

Refrigerator Internal lighting

Interior lighting for perfect visibility of shelves in the refrigerator compartment

Fruit and vegetable drawer

The fruit and vegetable drawer ensures the best storage conditions for fresh food, avoiding any contamination

Inverter compressor

Inverter compressor reduces noise and vibration levels for a quiet and comfortable kitchen environment

Inverter compressor technology offers significant advantages for refrigeration systems, improving both performance and efficiency. Better temperature control ensures a more stable and constant indoor environment, preserving the freshness of food. This technology also results in reduced energy consumption, as the compressor adjusts its speed according to cooling needs.

External display

External display for simple and intuitive control with quick access to information