

## RC20XDND



Product Family	Refrigerator
Installation	Free standing
Category	Bottom Mount
Reference width	Until 60 cm
Reference height	160 - 200 cm
Sistema Total No - Frost	Yes
Cooling type	Total No Frost
Defrost	Automatic
Hinge type	Standard
Hinge position	Right
Reversible door	Yes
EAN code	8017709343286



## Aesthetics



Aesthetic	Universale	Side material	Steel
Colour	Inox Look	Side colour	Silver
Material	Steel Effect	Logo	Applied
Handle	Integrated	Display	LED
Handle type	Fixed	Display position	Esterno (su porta)
Logo colour	Chrome		

## Refrigerator compartment features



Number of compartments	2	Bottle shelf	Yes
Compartment types	Low temperature compartment, Fruit and vegetable compartment	Type of crisper/vegetable drawers cover	Glass
No. of adjustable shelves	3	No. of lights refrigerator compartment	1
Number of fruit and vegetables drawers	1	Low temperature compartment	Yes
Shelves material	Glass	Internal light in fridge	Yes
Type of crisper/vegetable drawers cover	On sliding rails	Type of internal light (fridge)	LED
Crisper Cover	Yes		

## Refrigerator Inner Door

Number of adjustable door shelves	3	No. of bottle shelves	1
-----------------------------------	---	-----------------------	---

## Other Refrigerator features



Humidity Control Accessories	Yes, manual Bottle holder, Egg tray	MultiFlow	Yes
------------------------------	--	-----------	-----

## Freezer compartment features

Number of drawers	3
-------------------	---

## Other Freezer features

Accessories	1 ice box
-------------	-----------

## Other technical features



Functions display	Fast freezing, ECO
Door open alarm	Yes
Temperature Alarm	Yes
Type of temperature control	Electronic
No. of compressors	1
Refrigerant gas type	R600a
Type of compressor	Inverter
Foam agent	Cyclopentane

## Performance / Energy Label - Reg. 2019



Annual energy consumption	197 kWh/a	Airborne acoustical noise emissions	35 dB(A) re 1 pW
Energy efficiency class	D	Temperature Rise Time	10 h
Airborne acoustical noise emission class	B	4 star - Freezing capacity	10,0 kg/24h
Total net volume	331 l	Climate class	SN, N, ST, T
Sum of the volumes of the frozen compartment(s)	96 l	EEl	80 %

Sum of the volumes of the chill compartment(s) and the unfrozen compartment(s) 235 l

## Electrical Connection

Electrical connection rating	200 W	Frequency (Hz)	50 Hz
Current	0,9 A	Power supply cable length	200 cm
Voltage (V)	220-240 V	Plug	(F;E) Schuko

## Logistic Information

Width	600 mm	Height	2000 mm
Depth without handle	592 mm	Product width with maximum doors opening	600 mm

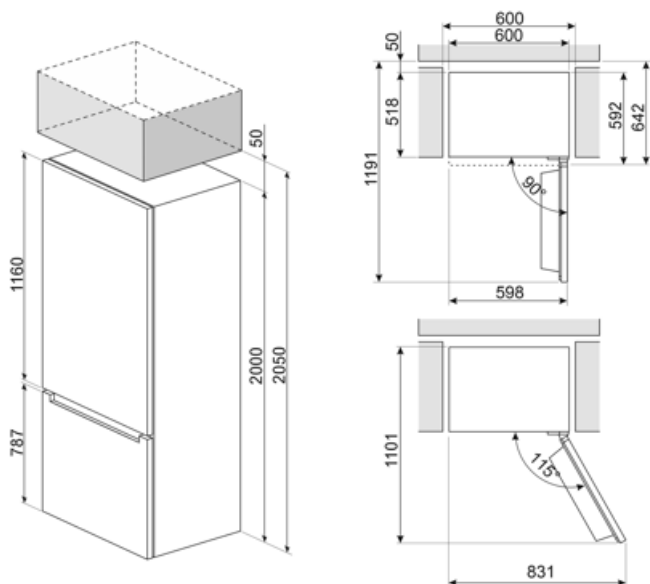

---

## Alternative products

---











**RC20KDND**

**Hinge position:** Right  
**Black Inox Look**

---

## Symbols glossary

---

- |  |  |   |  |
|--|--|---|--|
|  | The automatic defrost system works by automatically defrosting at regular intervals eliminating the need to defrost altogether.                          |  | Energy efficiency class D  |
|  | LED display: to show programmes, functions and options selected and the time to the end of the cycle.  |  | Economical mode: Analyzes fridge functioning during the activation and optimizes the operating cycle in order to reduce power consumption. |
|  | Fast freezing: The fast freezing function brings the temperature of the compartment down when activated a few hours prior to usage.                      |  | LED interior lighting: is a more energy efficient and long lasting way of illuminating the interior of the appliance.                      |
|  | Smeg's evolution towards more intelligent and eco-friendly models has led to the choice of Inverter technology, which significantly reduces consumption. |  | Multiflow Cooling System: the Multiflow ventilation system allows an even distribution of cool air around the fridge cabinet.              |