

RC20XDNE



| | |
|----------------------------------|----------------|
| Product Family | Refrigerator |
| Installation | Free Standing |
| Category | Bottom Mount |
| Reference width | Until 60 |
| Reference height | 160 - 200 |
| Cooling type | Total No Frost |
| Defrost | Automatic |
| Hinge type | Standard |
| Door opening flush with the wall | No |
| Slot-in | No |
| Hinge position | Right |
| Reversible door | Yes |
| EAN code | 8017709343262 |



Aesthetics



| | | | |
|-------------------------------------|--------------|-----------------|--------------------|
| Aesthetic | Universal | Side colour | Silver |
| Colour | Aspecto inox | Logotipo | Logotipo aplicado |
| Material | Steel Effect | Display | LED |
| Handle kit to be ordered separately | No | Mostrar porções | Externo (na porta) |
| Handle | Integrated | Dispenser | No |
| Handle type | Fixed | Water Filter | No |
| Logo colour | Chrome | HomeBar | No |
| Side material | Steel | | |

Refrigerator compartment features



| | | | |
|---|------------------|---|-------|
| No. of adjustable shelves | 3 | Type of crisper/vegetable drawers cover | Glass |
| Number of fruit and vegetables drawers | 1 | Nº de lâmpadas | 1 |
| Type of adjustable shelves | Glass | Life Plus zone-0°C | No |
| Type of crisper/vegetable drawers cover | On sliding rails | Compartimento baixa temperatura | Yes |
| Crisper Cover | Yes | Internal light in fridge | Yes |
| Bottle shelf | Yes | Type of internal light (fridge) | LED |

Refrigerator Inner Door

Number of adjustable door shelves 3

Adjustable door shelves with wire support No

No. of bottle shelves 1

Bottle shelves with wire support No

Other Refrigerator features



Accessories Bottle holder, Egg tray

Natural Plus Blu Light No

MultiFlow Yes

Fan No

Ionizer No

Tecnologia de titânio No

Filtro de odor antibacteriano No

Zona de cuidados biológicos No

Freezer compartment features

Number of drawers 3

Internal light in freezer No

Freezer Inner Door

Pizza box No

Other Freezer features

Accessories 1 ice box

Manual ice maker No

Ice maker No

Fast freezing compartment No

Ice tray shelf No

Other technical features



Functions display

MultiZone

Ligação à rede de água

Door open alarm

Temperature Alarm

Type of temperature control

No. of compressors

Refrigerant gas type

Type of compressor

Espuma expansiva de isolamento

Fast freezing, ECO

No

No

Yes

Yes

Electronic

1

R600a

Standard

Ciclopentano

Etiqueta de Desempenho / Energia - Reg. 2019







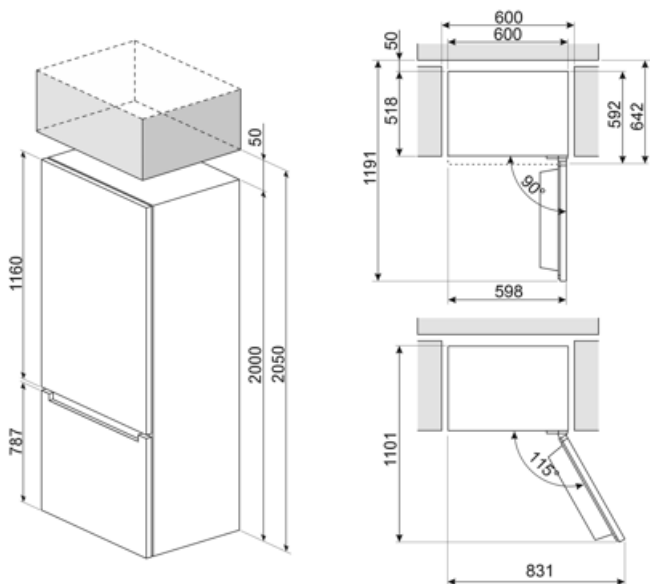

| | | | |
|---|-----------|--|------------------|
| Consumo de energia anual | 246 kWh/a | Airborne acoustical noise emissions | 38 dB(A) re 1 pW |
| Classe de eficiência energética | E | Autonomia de conservação sem energia elétrica | 10 h |
| Classe de emissão de ruído acústico aerotransportado | C | 4 estrelas - Capacidade de congelamento | 9.0 Kg/24h |
| Volume líquido total | 331 l | Classe climática | SN, N, ST, T |
| Soma dos volumes do(s) compartimento(s) congelado(s) | 96 l | EI | 100 % |
| Soma dos volumes do(s) compartimento(s) refrigerado(s) e do(s) compartimento(s) não congelado(s) | 235 l | | |

Electrical Connection

| | | | |
|-------------------------------------|--------------|----------------------------------|-----------|
| Plug | (F;E) Schuko | Voltage (V) | 220-240 V |
| Electrical connection rating | 70 W | Frequency (Hz) | 50 Hz |
| Current | 10 A | Power supply cable length | 200 cm |



Symbols glossary

- | | | | |
|--|--|---|--|
|  | O sistema de descongelamento automático funciona descongelando automaticamente em intervalos regulares, eliminando a necessidade de descongelar completamente. |  | Display LED: para mostrar os programas, funções e opções selecionadas e o tempo até ao final do ciclo. |
|  | Modo económico: Analisa o funcionamento da geladeira durante a ativação e otimiza o ciclo de funcionamento, a fim de reduzir o consumo de energia. |  | CONGELAMENTO RÁPIDO: A função de congelamento rápido reduz a temperatura do compartimento quando ativado algumas horas antes do uso. |
|  | Iluminação interior LED: é uma forma mais eficiente em termos energéticos e duradoura de iluminar o interior do aparelho. |  | Ar mais: mantém a comida mais fresca por mais tempo. |
|  | Classe de eficiência energética E. | | |

Benefit (TT)

No-Frost system

The No Frost system prevents the formation of ice and contributes to better preservation of food in the refrigerator

Plastic multiflow system

The Multiflow system ensures even distribution of cold air inside the refrigerator

Refrigerant gas R600a

Environmentally friendly R600a refrigerant gas contributes to rapid cooling with lower energy consumption

Reversible door

Reversible door ensures flexible installation and space optimisation

Refrigerator Internal lighting

Interior lighting for perfect visibility of shelves in the refrigerator compartment

Fruit and vegetable drawer

The fruit and vegetable drawer ensures the best storage conditions for fresh food, avoiding any contamination

External display

External display for simple and intuitive control with quick access to information