

RC20XND



Product familie	Koelkast
Installatie	Vrijstaand
Categorie	Koel-vriescombinatie
Referentie breedte	Tot 60 cm cm
Referentie hoogte	160 - 200 cm cm
No Frost systeem	Ja
Type koelen	No Frost
Ontdooien	Automatisch ontdooien
Type scharnier	Standaard
Positie scharnier	Rechts
Deur omkeerbaar	Ja
EAN-code	8017709343279



Design



Design	Universeel	Materiaal zijwanden	Staal
Kleur	Inox Look	Kleur zijkanten	Zilver
Materiaal deur	Inox look	Logo	Geassembleerd
Handgreep	Geïntegreerd	Display	LED
Type handgreep	Vast	Positie display	Binnen (bovenzijde)
Kleur logo	Chroom		

Uitrusting koelkast



Number of compartments	2	Flessenhouder	Ja
Compartment types	Low temperature compartment, Fruit and vegetable compartment	Type afdekplaat groente-/fruitlade	Glas
Aantal verstelbare leggers	3	Aantal lampen	1
Aantal groente-/fruitlades	1	Convertible temperature drawer	No
Shelves material	Glas	Low temperature compartment	Ja
Type afdekplaat groente-/fruitlade	Op telescopische geleiders	Binnenverlichting koelkast	Ja
Afdekplaat groentenlade	Ja	Type binnenverlichting koelkast	LED

Binnendeur koelkast

Aantal verstelbare
binnendeurcompartimenten 3

Aantal flessenhouders 1

Overige features koelkast



Humidity Control Yes, manual
Accessoires Flessenblokkering,
Eierhouder

MultiFlow Ja

Uitrusting vriezer

Aantal lades 3

Overige features vriezer

Accessoires 1 ijsblokeshouder

Overige technische eigenschappen



Display functies	Snel-vriesfunctie, ECO
Alarm open deur	Ja
Temperature Alarm	Ja
Type temperatuurcontrole	Elektronisch
Aantal compressoren	1
Type koelgas	R600a
Type compressor	Variabele toeren
Schuimmiddel	Cyclopentaan

Prestaties/Energie label - Reg. 2019



Annual energy consumption	197 kWh/jaar	Geluidsniveau	35 dB(A) re 1 pW
Energie-efficiëntieklasse	D	Conserveringsduur zonder stroom	10 h
Emissieklasse voor akoestisch luchtgeluid	B	4 star - Freezing capacity	10,0 kg/24h
Totaal netto volume	331 l	Klimaatklasse	SN, N, ST, T
Netto inhoud vriesgedeelte	96 l	EEl	80 %
Netto inhoud koelgedeeltes	235 l		

Elektrische aansluiting







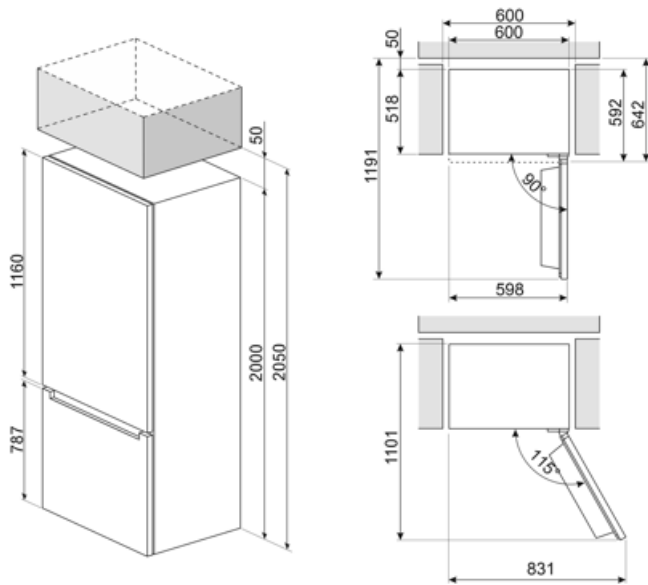

Nominale aansluitwaarde	200 W	Frequentie (Hz)	50 Hz
Stroom (A)	0,9 A	Lengte stroomkabel	200 cm
Spanning (V)	220-240 V	Stekker	(F;E) Schuko

Logistieke informatie

Breedte product (mm)	600 mm	Maximum hoogte	2000 mm
Diepte zonder handvat en spacer	592 mm		



Symbols glossary

	The automatic defrost system works by automatically defrosting at regular intervals eliminating the need to defrost altogether.		Energie-efficiëntieklasse
	LED display: to show programmes, functions and options selected and the time to the end of the cycle.		Economical mode: Analyzes fridge functioning during the activation and optimizes the operating cycle in order to reduce power consumption.
	Fast freezing: The fast freezing function brings the temperature of the compartment down when activated a few hours prior to usage.		LED interior lighting: is a more energy efficient and long lasting way of illuminating the interior of the appliance.
	De evolutie van Smeg vaatwassers naar meer intelligente en milieuvriendelijke modellen heeft ertoe geleid om de inverter technologie te gebruiken, die een significante energie- en geluidsbesparing met zich meebrengt.		Multiflow Cooling System: the Multiflow ventilation system allows an even distribution of cool air around the fridge cabinet.