

# RC33KNZA



<b>Product Family</b>	Refrigerator
<b>Installation</b>	Free standing
<b>Category</b>	Bottom Mount
<b>Reference width</b>	Until 60 cm
<b>Reference height</b>	160 - 200 cm
<b>Sistema Total No - Frost</b>	Yes
<b>Cooling type</b>	Total No Frost
<b>Defrost</b>	Automatic
<b>Hinge type</b>	Standard
<b>Hinge position</b>	Right
<b>Reversible door</b>	Yes
<b>EAN code</b>	8017709344832



## Aesthetics



<b>Aesthetic</b>	Universale	<b>Side colour</b>	Dark grey
<b>Colour</b>	Dark Grey Inox Look	<b>Logo</b>	Applied
<b>Design</b>	Flat	<b>Door shelves profile color</b>	Dark Inox Look
<b>Finishing</b>	Fingerproof	<b>Drawers profile color</b>	Dark Inox Look
<b>Material</b>	Steel Effect	<b>Color of glass shelf profile</b>	Dark Inox Look
<b>Handle</b>	Integrated	<b>Display</b>	LED
<b>Logo colour</b>	Silver	<b>Display position</b>	Interno (cella frigo)
<b>Side material</b>	Steel		

## Refrigerator compartment features



<b>Number of compartments</b>	1	<b>Crisper Cover</b>	Yes
<b>Compartment types</b>	Fruit and vegetable compartment	<b>Bottle shelf</b>	Yes
<b>No. of adjustable shelves</b>	3	<b>Type of crisper/vegetable drawers cover</b>	Glass
<b>Number of fruit and vegetables drawers</b>	1	<b>No. of lights refrigerator compartment</b>	2
<b>Shelves material</b>	Glass	<b>Internal light in fridge</b>	Yes
<b>Type of crisper/vegetable drawers cover</b>	Standard	<b>Type of internal light (fridge)</b>	LED

## Refrigerator Inner Door

Number of adjustable door shelves	2	No. of bottle shelves	1
-----------------------------------	---	-----------------------	---

## Other Refrigerator features



Humidity Control	Yes	MultiFlow	Yes
Accessories	Egg tray	Fan	Yes

## Freezer compartment features

Number of drawers	3
-------------------	---

## Other Freezer features

Accessories	2 ice boxes
-------------	-------------

## Other technical features



Functions display	Fast freezing, ECO
Fast freezing button	Yes
Door open alarm	Yes
Type of temperature control	Electronic
No. of compressors	1
Refrigerant gas type	R600a
Type of compressor	Inverter
Refrigerant Quantity (gr)	50 g
Foam agent	Cyclopentane

## Performance / Energy Label - Reg. 2019

Total net volume	324 l	Airborne acoustical noise emissions	42 dB(A) re 1 pW
Sum of the volumes of the frozen compartment(s)	94 l	4 star - Freezing capacity	5,0 kg/24h
Sum of the volumes of the chill compartment(s) and the unfrozen compartment(s)	230 l	Climate class	SN, T

## Electrical Connection

Electrical connection rating	145 W	Frequency (Hz)	50 Hz
Current	1,1 A	Power supply cable length	210 cm
Voltage (V)	220-240 V	Plug	(F;E) Schuko

## Logistic Information

Width	595 mm	Product width with maximum doors opening	982 mm
Depth without handle	650 mm	Product depth with doors open at 90°	1244 mm
Height	1860 mm	Spacer depth	38 mm

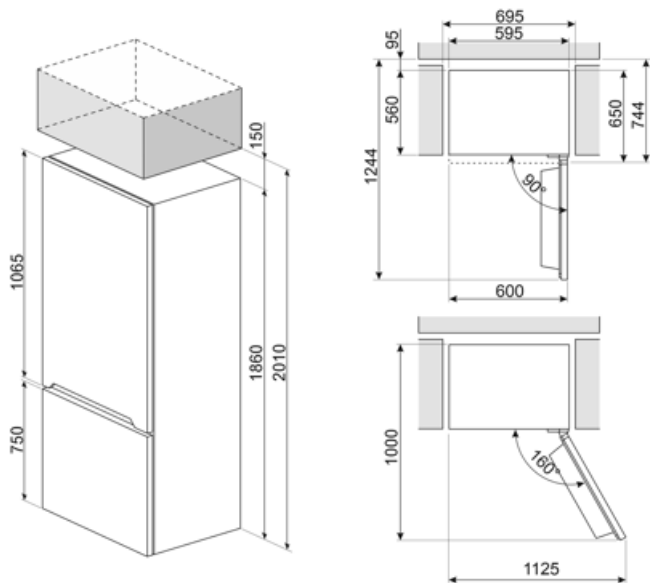

---

## Alternative products









---



**RC33SNZA**

**Hinge position:** Right  
**Pet Inox Look**

## Symbols glossary

	The automatic defrost system works by automatically defrosting at regular intervals eliminating the need to defrost altogether.		LED display: to show programmes, functions and options selected and the time to the end of the cycle.
	Economical mode: Analyzes fridge functioning during the activation and optimizes the operating cycle in order to reduce power consumption.		Ventilated: Forced distribution of cold air in the refrigerator compartment, which allows even temperature distribution within the fridge.
	Fast freezing: The fast freezing function brings the temperature of the compartment down when activated a few hours prior to usage.		LED interior lighting: is a more energy efficient and long lasting way of illuminating the interior of the appliance.
	Smeg's evolution towards more intelligent and eco-friendly models has led to the choice of Inverter technology, which significantly reduces consumption.		Multiflow Cooling System: the Multiflow ventilation system allows an even distribution of cool air around the fridge cabinet.