

RI76LSI



Product Family	Refrigerator
Installation	Built-in
Category	Bottom Mount
Built-in niche	>200
Reference width	70 - 80 cm
Reference height	Higher than 200 cm
No-Frost system	Total
Cooling type	Fan assisted refrigerator, no-frost freezer
Defrost	Automatic
Hinge type	Door on door
Hinge position	Left
EAN code	8017709205119



Aesthetics



Aesthetics	Universal	Side colour	Silver
Colour	Stainless steel	Logo	Silk screen
Design	Flat	Display	LCD Touch
Material	Metal sheet	Display position	
Handle type	Fixed	Water Filter	Yes
Side material	Steel		

Refrigerator compartment features



No. of adjustable shelves	3	Type of crisper/vegetable drawers cover	Glass
Number of fruit and vegetables drawers	1	Life Plus zone-0°C	Yes
Shelves material	Glass	Internal light in fridge	Yes
Type of crisper/vegetable drawers cover	On sliding rails	Type of internal light (fridge)	LED
Crisper Cover	Yes		

Refrigerator Inner Door

Number of adjustable door shelves	2	No. of bottle shelves	1
		Bottle shelves with wire support	Yes

Adjustable door shelves Yes
with wire support

Other Refrigerator features



MultiFlow

Yes

Ionizer

Freezer compartment features

Number of drawers 2

Internal light in freezer Yes

Type of internal light (freezer) LED

Type of shelves Glass

Other Freezer features

Accessories 1 ice box
Ice maker Automatic

Ice tray shelf Yes

Other technical features



Functions display

Holiday, Fast freezing, Fast cooling, MultiZone, Control lock, Temperature alarm, Cooling timer, Demo Mode, Sabbath

MultiZone

Yes

Water network connection

Yes

Temperature alarm lamp

Yes

Door open alarm

Yes

Temperature Alarm

Acoustic and visual

Type of temperature control

Electronic

No. of compressors

2

Refrigerant gas type

R600a

Type of compressor

Inverter

Refrigerant Quantity (g)

48 g

Foam agent

Cyclopentane

Performance / Energy Label



Annual energy consumption 323 kWh/year

Energy efficiency class F

Airborne acoustical noise emission class C

Total volume 320 l

Sum of the volumes of the chill compartment(s) and the unfrozen compartment(s) 320 l

Noise level 41 dB(A) re 1 pW

Thaw time 10 h

Climatic class SN, N, ST, T

Sum of the volumes of the frozen compartment(s) 105 l

EEI

122 %

Electrical Connection

Nominal power 240 W
Current 1,4 A
Voltage (V) 220-240 V

Frequency (Hz) 50 Hz
Power supply cable length 200 cm
Plug (F;E) Schuko







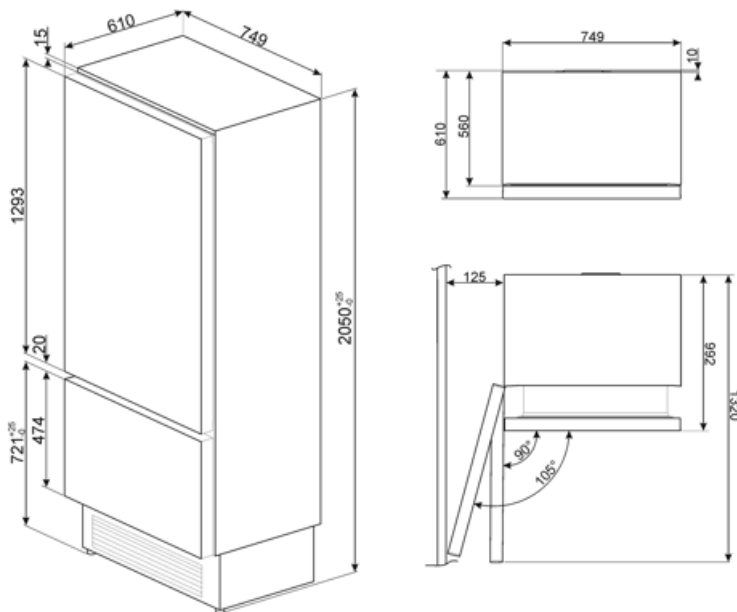







Logistic Information

Width (mm) 749 mm
Depth without handle 610 mm
Product Height with feet 2050 mm

Product width with maximum doors opening 874 mm
Product depth with doors open at 90° 1320 mm
Spacer depth 10 mm



Symbols glossary

	4 stars freezing compartment for better food preservation.		The automatic defrost system works by automatically defrosting at regular intervals eliminating the need to defrost altogether.
	A+: Energy efficiency class A+ helps to save up to 10% energy compared to class A. Maximum performance with minimum consumption is guaranteed.		Child lock: some models are fitted with a device to lock the programme/cycle so it cannot be accidentally changed.
	LCD display: to optimize performance and simplify the use of the appliance.		Fast freezing: The fast freezing function brings the temperature of the compartment down when activated a few hours prior to usage.
	Power saving mode: The power saving mode allows you to disable the refrigerator and keep the freezer working.		LED interior lighting: is a more energy efficient and long lasting way of illuminating the interior of the appliance.
	Life Plus 0°C: The temperature in the Lifeplus compartments is kept at 0°C, which preserves fresh meat and fish longer.		Inverter technology: The evolution of Smeg's driers towards more intelligent and environmentally sustainable models has led to the choice of using Inverter technology with heat pumps, which reduces significantly energy consumption.
	Air plus: keeps food fresher for longer.		Multizone: Multizone compartment can be used as a refrigerator or a freezer compartment. Depending on your needs and eating habits, you can select settings, program the temperature using.
	No Frost: The No Frost and Frost free systems prevent ice from forming so that no defrosting is required.		Sabbath: This function allows you to cook food whilst respecting the provisions of the Jewish day of rest.
	Energy efficiency class F		