

## RI76LSI



|                                 |   |
|---------------------------------|---|
| <b>Product Family</b>           | Refrigerator                                |
| <b>Installation</b>             | Built-in                                    |
| <b>Category</b>                 | Bottom Mount                                |
| <b>Built-in niche</b>           | >200  |
| <b>Reference width</b>          | 70 - 80                                     |
| <b>Reference height</b>         | Higher than 200                             |
| <b>Sistema Total No - Frost</b> | Total                                       |
| <b>Cooling type</b>             | Fan assisted refrigerator, no-frost freezer |
| <b>Defrost</b>                  | Automatic                                   |
| <b>Hinge type</b>               | Door on door                                |
| <b>Hinge position</b>           | Left  |
| <b>Reversible door</b>          | No  |
| <b>EAN code</b>                 | 8017709205119                               |



## Aesthetics



|  |                 |                                      |                      |
|--|-----------------|--------------------------------------|----------------------|
| <b>Aesthetic</b>                           | Universal       | <b>Logotipo</b>                      | Logotipo serigrafado |
| <b>Colour</b>                              | Stainless steel | <b>Display</b>                       | LCD Touch            |
| <b>Design</b>                              | Flat            | <b>Mostrar porções</b>               |                      |
| <b>Material</b>                            | Metal sheet     | <b>Dispenser</b>                     | No                   |
| <b>Handle kit to be ordered separately</b> | No              | <b>Water Filter</b>                  | Yes                  |
| <b>Handle type</b>                         | Fixed           | <b>HomeBar</b>                       | No                   |
| <b>Side material</b>                       | Steel           | <b>Alternative colours available</b> | No                   |
| <b>Side colour</b>                         | Silver          |                                      |                      |

## Refrigerator compartment features



|  |                  |  |       |
|--|------------------|--|-------|
| <b>No. of adjustable shelves</b>               | 3                | <b>Bottle shelf</b>                            | No    |
| <b>Number of fruit and vegetables drawers</b>  | 1                | <b>Type of crisper/vegetable drawers cover</b> | Glass |
| <b>Type of adjustable shelves</b>              | Glass            | <b>Life Plus zone-0°C</b>                      | Yes   |
| <b>Type of crisper/vegetable drawers cover</b> | On sliding rails | <b>Internal light in fridge</b>                | Yes   |
| <b>Crisper Cover</b>                           | Yes              | <b>Type of internal light (fridge)</b>         | LED   |

## Refrigerator Inner Door

|  |     |   |     |
|--|-----|---|-----|
| <b>Number of adjustable door shelves</b>         | 2   | <b>No. of bottle shelves</b>            | 1   |
| <b>Adjustable door shelves with wire support</b> | Yes | <b>Bottle shelves with wire support</b> | Yes |

## Other Refrigerator features



|   |           |                    |    |
|---|-----------|--------------------|----|
| <b>Natural Plus Blu Light MultiFlow</b> | No<br>Yes | <b>Fan Ionizer</b> | No |
|---|-----------|--------------------|----|

## Freezer compartment features

|                                  |     |   |       |
|----------------------------------|-----|---|-------|
| <b>Number of drawers</b>         | 2   | <b>Type of internal light (freezer)</b> | LED   |
| <b>Internal light in freezer</b> | Yes | <b>Type of shelves</b>                  | Glass |

## Other Freezer features

|                    |           |                                  |     |
|--------------------|-----------|----------------------------------|-----|
| <b>Accessories</b> | 1 ice box | <b>Fast freezing compartment</b> | No  |
| <b>Ice maker</b>   | Automatic | <b>Ice tray shelf</b>            | Yes |

## Other technical features



|                                       |   |
|---------------------------------------|---|
| <b>Functions display</b>              | Holiday, Fast freezing, Fast cooling, MultiZone, Control lock, Temperature alarm, Cooling timer, Demo Mode, Sabbath |
| <b>MultiZone</b>                      | Yes   |
| <b>Fast freezing button</b>           | No  |
| <b>Ligação à rede de água</b>         | Yes   |
| <b>Temperature alarm lamp</b>         | Yes   |
| <b>Door open alarm</b>                | Yes   |
| <b>Temperature Alarm</b>              | Acoustic and visual   |
| <b>Type of temperature control</b>    | Electronic  |
| <b>No. of compressors</b>             | 2   |
| <b>Refrigerant gas type</b>           | R600a   |
| <b>Type of compressor</b>             | Inverter  |
| <b>Refrigerant Quantity (gr)</b>      | 48 g  |
| <b>Espuma expansiva de isolamento</b> | Ciclopentano  |

## Etiqueta de Desempenho / Energia - Reg. 2019



|                                 |           |
|---------------------------------|-----------|
| <b>Consumo de energia anual</b> | 323 kWh/a |
|---------------------------------|-----------|







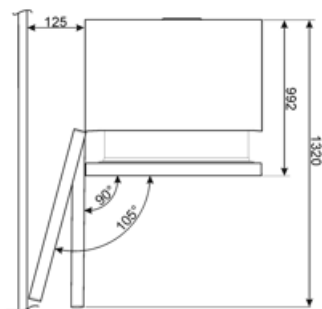
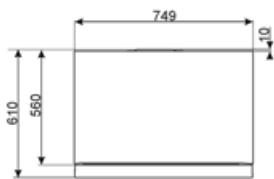
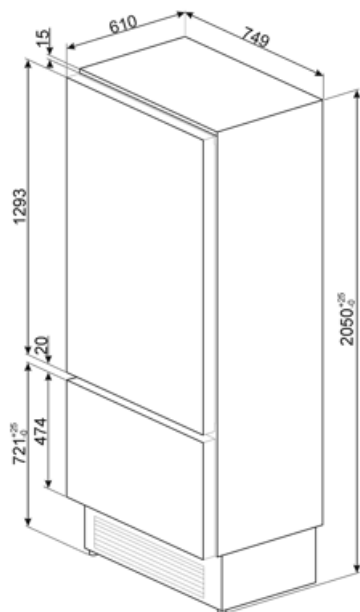







|  |       |  |                  |
|--|-------|--|------------------|
| Classe de eficiência energética                      | F     | Soma dos volumes do(s) compartimento(s) refrigerado(s) e do(s) compartimento(s) não congelado(s) | 320 l            |
| Classe de emissão de ruído acústico aerotransportado | C     | Airborne acoustical noise emissions  | 41 dB(A) re 1 pW |
| Volume líquido total                                 | 320 l | Autonomia de conservação sem energia elétrica  | 10 h             |
| Soma dos volumes do(s) compartimento(s) congelado(s) | 105 l | Classe climática   | SN, N, ST, T     |
|  |       | EI   | 122 %            |

## Electrical Connection

|                              |              |                           |           |
|------------------------------|--------------|---------------------------|-----------|
| Plug                         | (F;E) Schuko | Voltage (V)               | 220-240 V |
| Electrical connection rating | 240 W        | Frequency (Hz)            | 50 Hz     |
| Current                      | 1,4 A        | Power supply cable length | 200 cm    |



## Symbols glossary

-  Compartimento de congelamento de 4 estrelas para uma melhor preservação dos alimentos.
-  O sistema de descongelamento automático funciona descongelando automaticamente em intervalos regulares, eliminando a necessidade de descongelar completamente.
-  Display LCD: para otimizar o desempenho e simplificar o uso do aparelho.
-  Modo de economia de energia: O modo de economia de energia permite-lhe desativar a geladeira e manter o congelador a funcionar.
-  Life Plus 0°C: A temperatura nos compartimentos Lifeplus é mantida a 0°C, o que preserva a carne fresca e o peixe por mais tempo.
-  Ar mais: mantém a comida mais fresca por mais tempo.
-  No Frost: Os sistemas sem geada e livre de geada impedem a formação de gelo, de modo que não é necessário descongelar.
-  Classe de eficiência energética F
-  A+: A classe de eficiência energética A+ ajuda a economizar até 10% de energia em comparação com a classe A. O desempenho máximo com consumo mínimo é garantido.
-  Bloqueio para crianças: alguns modelos estão equipados com um dispositivo para bloquear o programa/ciclo para que não possa ser acidentalmente alterado.
-  CONGELAMENTO RÁPIDO: A função de congelamento rápido reduz a temperatura do compartimento quando ativado algumas horas antes do uso.
-  Iluminação interior LED: é uma forma mais eficiente em termos energéticos e duradoura de iluminar o interior do aparelho.
-  Tecnologia do inversor: A evolução dos secadores Smeg para modelos mais inteligentes e ambientalmente sustentáveis levou à escolha do uso da tecnologia do inversor com bombas de calor, o que reduz significativamente o consumo de energia.
-  Multizona: O compartimento multizona pode ser usado como uma geladeira ou um compartimento congelador. Dependendo das suas necessidades e hábitos alimentares, você pode selecionar configurações, programar a temperatura.
-  Sábado Esta função permite cozinhar alimentos durante o sábado, o feriado de descanso na religião judaica, respeitando os preceitos. O forno funciona

---

## Benefit (TT)

---

### **Plastic multiflow system**

The Multiflow system ensures even distribution of cold air inside the refrigerator

### **Multizone (variable temperature compartment)**

The Multizone system isolates a freezer compartment with adjustable temperature independent of the main compartment, to give maximum storage flexibility

The Multizone compartment can be used both as a freezer and as a refrigerator. Depending on one's needs and eating habits, each user can choose how to set it, programming the temperature via the external display.

### **Refrigerant gas R600a**

Environmentally friendly R600a refrigerant gas contributes to rapid cooling with lower energy consumption

### **Climate class**

Climatic class SN-T makes the appliance suitable for working at room temperature between 10 °C and 43 °C (50 °F ~ 109 °F)

### **Self-supporting hinges**

Self-supporting hinges ensure a perfect fit between the equipment door and the cabinet door, giving the product a minimalist and elegant appearance

### **Life Plus 0°**

Temperature-controlled Life Plus compartment for optimal storage of specific food categories

### **Refrigerator Internal lighting**

Interior lighting for perfect visibility of shelves in the refrigerator compartment

### **Freezer internal lighting**

Interior lighting for perfect visibility of the drawers in the freezer compartment

### **Fruit and vegetable drawer**

The fruit and vegetable drawer ensures the best storage conditions for fresh food, avoiding any contamination

### **Inverter compressor**

Inverter compressor reduces noise and vibration levels for a quiet and comfortable kitchen environment

Inverter compressor technology offers significant advantages for refrigeration systems, improving both performance and efficiency. Better temperature control ensures a more stable and constant indoor environment, preserving the freshness of food. This technology also results in reduced energy consumption, as the compressor adjusts its speed according to cooling needs.

---

## Automatic Ice Maker

Automatic ice maker for ice always available when needed

The automatic ice maker is connected directly to the kitchen water supply, so there is no need to manually fill any tanks. This saves considerable time and ensures hygiene and convenience.