

RI76RSI



Product Family	Refrigerator
Installation	Built-in
Category	Bottom Mount
Built-in niche	>200
Reference width	70 - 80
Reference height	Higher than 200
Sistema Total No - Frost	Total
Cooling type	Fan assisted refrigerator, no-frost freezer
Defrost	Automatic
Hinge type	Door on door
Hinge position	Right
Reversible door	No
EAN code	8017709205102



Aesthetics



Aesthetic	Universal	Logotipo	Logotipo serigrafado
Colour	Stainless steel	Display	LCD
Design	Flat	Mostrar porções	
Material	Metal sheet	Dispenser	No
Handle kit to be ordered separately	No	Water Filter	Yes
Handle type	Fixed	HomeBar	No
Side material	Steel	Alternative colours available	No
Side colour	Silver		

Refrigerator compartment features

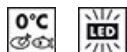

No. of adjustable shelves	3	Bottle shelf	No
Number of fruit and vegetables drawers	1	Type of crisper/vegetable drawers cover	Glass
Type of adjustable shelves	Glass	Life Plus zone-0°C	Yes
Type of crisper/vegetable drawers cover	On sliding rails	Internal light in fridge	Yes
Crisper Cover	Yes	Type of internal light (fridge)	LED

Refrigerator Inner Door

Number of adjustable door shelves	2	No. of bottle shelves	1
Adjustable door shelves with wire support	Yes	Bottle shelves with wire support	Yes

Other Refrigerator features



Natural Plus Blu Light MultiFlow	No Yes	Fan Ionizer	No
---	-----------	--------------------	----

Freezer compartment features

Number of drawers	2	Type of internal light (freezer)	LED
Internal light in freezer	Yes	Type of shelves	Glass

Other Freezer features

Accessories Ice maker	Automatic	Fast freezing compartment Ice tray shelf	No Yes
------------------------------	-----------	---	-----------

Other technical features



Functions display	Holiday, Fast freezing, Fast cooling, MultiZone, Control lock, Temperature alarm, Cooling timer, Demo Mode, Sabbath
MultiZone	Yes
Fast freezing button	No
Ligação à rede de água	Yes
Temperature alarm lamp	Yes
Door open alarm	Yes
Temperature Alarm	Acoustic and visual
Type of temperature control	Electronic
No. of compressors	2
Refrigerant gas type	R600a
Type of compressor	Inverter
Refrigerant Quantity (gr)	48 g
Espuma expansiva de isolamento	Ciclopentano

Etiqueta de Desempenho / Energia - Reg. 2019



Consumo de energia anual	323 kWh/a
---------------------------------	-----------







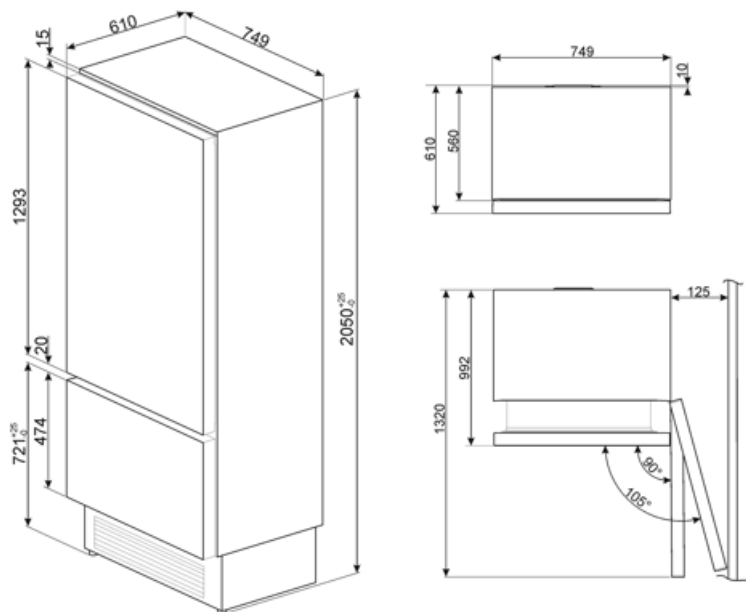







Classe de eficiência energética	F	Soma dos volumes do(s) compartimento(s) refrigerado(s) e do(s) compartimento(s) não congelado(s)	320 l
Classe de emissão de ruído acústico aerotransportado	C	Airborne acoustical noise emissions	41 dB(A) re 1 pW
Volume líquido total	320 l	Autonomia de conservação sem energia elétrica	10 h
Soma dos volumes do(s) compartimento(s) congelado(s)	105 l	Classe climática	SN, N, ST, T
		EI	122 %

Electrical Connection

Plug	(F;E) Schuko	Voltage (V)	220-240 V
Electrical connection rating	240 W	Frequency (Hz)	50 Hz
Current	1,4 A	Power supply cable length	200 cm



Symbols glossary

-  Compartimento de congelamento de 4 estrelas para uma melhor preservação dos alimentos.
-  O sistema de descongelamento automático funciona descongelando automaticamente em intervalos regulares, eliminando a necessidade de descongelar completamente.
-  Display LCD: para otimizar o desempenho e simplificar o uso do aparelho.
-  Modo de economia de energia: O modo de economia de energia permite-lhe desativar a geladeira e manter o congelador a funcionar.
-  Life Plus 0°C: A temperatura nos compartimentos Lifeplus é mantida a 0°C, o que preserva a carne fresca e o peixe por mais tempo.
-  Ar mais: mantém a comida mais fresca por mais tempo.
-  No Frost: Os sistemas sem geada e livre de geada impedem a formação de gelo, de modo que não é necessário descongelar.
-  Classe de eficiência energética F
-  A+: A classe de eficiência energética A+ ajuda a economizar até 10% de energia em comparação com a classe A. O desempenho máximo com consumo mínimo é garantido.
-  Bloqueio para crianças: alguns modelos estão equipados com um dispositivo para bloquear o programa/ciclo para que não possa ser acidentalmente alterado.
-  CONGELAMENTO RÁPIDO: A função de congelamento rápido reduz a temperatura do compartimento quando ativado algumas horas antes do uso.
-  Iluminação interior LED: é uma forma mais eficiente em termos energéticos e duradoura de iluminar o interior do aparelho.
-  Tecnologia do inversor: A evolução dos secadores Smeg para modelos mais inteligentes e ambientalmente sustentáveis levou à escolha do uso da tecnologia do inversor com bombas de calor, o que reduz significativamente o consumo de energia.
-  Multizona: O compartimento multizona pode ser usado como uma geladeira ou um compartimento congelador. Dependendo das suas necessidades e hábitos alimentares, você pode selecionar configurações, programar a temperatura.
-  Sábado Esta função permite cozinhar alimentos durante o sábado, o feriado de descanso na religião judaica, respeitando os preceitos. O forno funciona

Benefit (TT)

Plastic multiflow system

The Multiflow system ensures even distribution of cold air inside the refrigerator

Multizone (variable temperature compartment)

The Multizone system isolates a freezer compartment with adjustable temperature independent of the main compartment, to give maximum storage flexibility

The Multizone compartment can be used both as a freezer and as a refrigerator. Depending on one's needs and eating habits, each user can choose how to set it, programming the temperature via the external display.

Refrigerant gas R600a

Environmentally friendly R600a refrigerant gas contributes to rapid cooling with lower energy consumption

Climate class

Climatic class SN-T makes the appliance suitable for working at room temperature between 10 °C and 43 °C (50 °F ~ 109 °F)

Self-supporting hinges

Self-supporting hinges ensure a perfect fit between the equipment door and the cabinet door, giving the product a minimalist and elegant appearance

Life Plus 0°

Temperature-controlled Life Plus compartment for optimal storage of specific food categories

Refrigerator Internal lighting

Interior lighting for perfect visibility of shelves in the refrigerator compartment

Freezer internal lighting

Interior lighting for perfect visibility of the drawers in the freezer compartment

Fruit and vegetable drawer

The fruit and vegetable drawer ensures the best storage conditions for fresh food, avoiding any contamination

Inverter compressor

Inverter compressor reduces noise and vibration levels for a quiet and comfortable kitchen environment

Inverter compressor technology offers significant advantages for refrigeration systems, improving both performance and efficiency. Better temperature control ensures a more stable and constant indoor environment, preserving the freshness of food. This technology also results in reduced energy consumption, as the compressor adjusts its speed according to cooling needs.

Automatic Ice Maker

Automatic ice maker for ice always available when needed

The automatic ice maker is connected directly to the kitchen water supply, so there is no need to manually fill any tanks. This saves considerable time and ensures hygiene and convenience.