

## RI96LSI



Product Family	Refrigerator
Installation	Built-in
Category	Bottom Mount
Built-in niche	>200
Reference width	Higher than 80 cm
Reference height	Higher than 200 cm
Sistema Total No - Frost	Total
Cooling type	Fan assisted refrigerator, no-frost freezer
Defrost	Automatic
Hinge type	Door on door
Hinge position	Left
EAN code	8017709205096



## Aesthetics



Aesthetic	Universale	Logo	Silk screen
Material	Metal sheet	Display	LCD Touch
Handle	Not included	Display position	
Side material	Steel	Water Filter	Internal
Side colour	Silver		

## Refrigerator compartment features



No. of adjustable shelves	3	Type of crisper/vegetable drawers cover	Glass
Number of fruit and vegetables drawers	1	Life Plus zone-0°C	Yes
Shelves material	Glass	Internal light in fridge	Yes
Type of crisper/vegetable drawers cover	On sliding rails	Type of internal light (fridge)	LED
Crisper Cover	Yes		

## Refrigerator Inner Door

Number of adjustable door shelves	2	No. of bottle shelves	1
Adjustable door shelves with wire support	Yes	Bottle shelves with wire support	Yes

## Other Refrigerator features



MultiFlow

Yes

Ionizer

## Freezer compartment features

Number of drawers

2

Internal light in freezer

Yes

Type of internal light  
(freezer)

LED

## Other Freezer features

Ice maker

Automatic with tap water  
connection

Ice tray shelf

Yes

## Other technical features



Functions display

Holiday, Fast freezing, Fast cooling, MultiZone, Control lock, Temperature alarm, Cooling timer, Demo Mode, Sabbath

MultiZone

Yes

Water network connection

Yes

Temperature alarm lamp

Yes

Door open alarm

Yes

Temperature Alarm

Acoustic and visual

Type of temperature control

Electronic

No. of compressors

2

Refrigerant gas type

R600a

Type of compressor

Inverter

Refrigerant Quantity (g)

48 g

Foam agent

Cyclopentane

## Performance / Energy Label - Reg. 2019



Annual energy  
consumption

342 kWh/a

Energy efficiency class

F

Airborne acoustical  
noise emission class

C

Total net volume

131 l

Sum of the volumes of  
the frozen  
compartment(s)

131 l

Sum of the volumes of  
the chill compartment(s)  
and the unfrozen  
compartment(s)

425 l

Airborne acoustical  
noise emissions

41 dB(A) re 1 pW

Temperature Rise Time

10 h

Climate class

SN, N, ST, T

EEL

116 %

## Electrical Connection







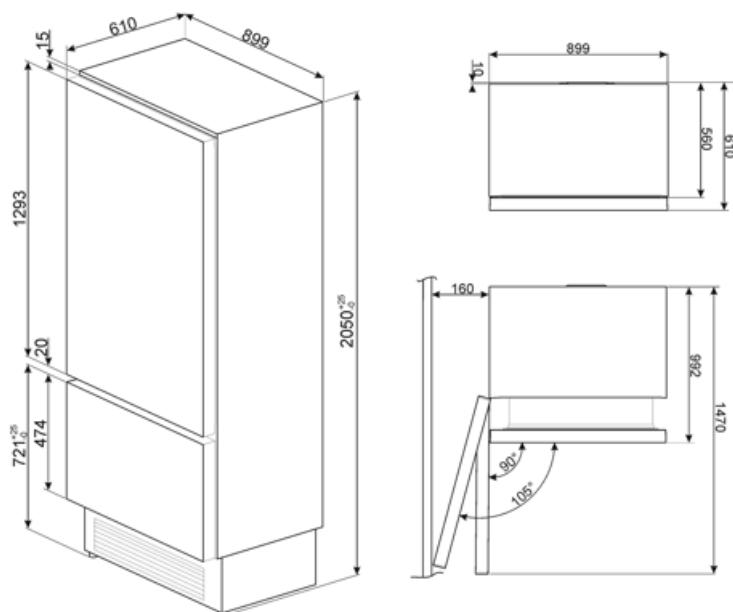







Electrical connection rating	240 W	Frequency (Hz)	50 Hz
Current	1,5 A	Power supply cable length	250 cm
Voltage (V)	220-240 V	Plug	(F;E) Schuko

## Logistic Information

Width	899 mm	Product width with maximum doors opening	900 mm
Depth without handle	610 mm	Product depth with doors open at 90°	1470 mm
Height	2050 mm	Spacer depth	10 mm



## Symbols glossary

 <p>4 stars freezing compartment for better food preservation.</p>	 <p>The automatic defrost system works by automatically defrosting at regular intervals eliminating the need to defrost altogether.</p>
 <p>Child lock: some models are fitted with a device to lock the programme/cycle so it cannot be accidentally changed.</p>	 <p>A+: Energy efficiency class A+ helps to save up to 10% energy compared to class A. Maximum performance with minimum consumption is guaranteed.</p>
 <p>Energy efficiency class F</p>	 <p>LCD display: to optimize performance and simplify the use of the appliance.</p>
 <p>Fast freezing: The fast freezing function brings the temperature of the compartment down when activated a few hours prior to usage.</p>	 <p>Power saving mode: The power saving mode allows you to disable the refrigerator and keep the freezer working.</p>
 <p>LED interior lighting: is a more energy efficient and long lasting way of illuminating the interior of the appliance.</p>	 <p>Life Plus 0°C: The temperature in the Lifeplus compartments is kept at 0°C, which preserves fresh meat and fish longer.</p>
 <p>Smeg's evolution towards more intelligent and eco-friendly models has led to the choice of Inverter technology, which significantly reduces consumption.</p>	 <p>Multiflow Cooling System: the Multiflow ventilation system allows an even distribution of cool air around the fridge cabinet.</p>
 <p>Multizone: Multizone compartment can be used as a refrigerator or a freezer compartment. Depending on your needs and eating habits, you can select settings, program the temperature using.</p>	 <p>No Frost: The No Frost and Frost free systems prevent ice from forming so that no defrosting is required.</p>
 <p>SABBATH: function that allows to cook food respecting Judaism's day of rest provisions.</p>	