

S4C092E



Product Family	Refrigerator
Installation	Built-in
Category	One Door
Built-in niche	88
Reference width	Until 60
Reference height	Until 100
Cooling type	Static
Defrost	Automatic for refrigerator, manual for freezer
Hinge type	Sliding
Hinge position	Right
Reversible door	Yes
EAN code	8017709337087



Aesthetics

Aesthetic	Universal	Logotipo	Logotipo serigrafado
Colour	White	Cor do perfil das prateleiras da porta	White
Design	Flat	Cor do perfil da prateleira de vidro	White
Material	Metal sheet	Display	No
Handle kit to be ordered separately	No	Dispenser	No
Side material	Steel	Water Filter	No
Side colour	White	HomeBar	No

Refrigerator compartment features



No. of adjustable shelves	2	Type of crisper/vegetable drawers cover	Glass
Number of fruit and vegetables drawers	1	Life Plus zone-0°C	No
Type of adjustable shelves	Glass	Compartimento baixa temperatura	No
Type of crisper/vegetable drawers cover	Standard	Internal light in fridge	Yes
Crisper Cover	Yes	Type of internal light (fridge)	LED
Bottle shelf	No		

Refrigerator Inner Door

No. of door shelves with transparent cover	1	No. of bottle shelves	1
Number of adjustable door shelves	2	Bottle shelves with wire support	No
Adjustable door shelves with wire support	No		

Other Refrigerator features

Accessories	Egg tray	Fan	No
Natural Plus Blu Light	No	Ionizer	No
MultiFlow	No		

Freezer compartment features

Internal freezer compartment	Yes	Type of internal light (freezer)	No
Internal light in freezer	No		

Other technical features

Freezer compartment accessories	Ice cube tray
Power on lamp	No
Temperature alarm lamp	No
Door open alarm	No
Temperature Alarm	No
Type of temperature control	Electronic
No. of compressors	1
Refrigerant gas type	R600a
Type of compressor	Standard
Refrigerant Quantity (gr)	31 g
Espuma expansiva de isolamento	Ciclopentano

Etiqueta de Desempenho / Energia - Reg. 2019

			
Consumo de energia anual	143 kWh/a	Airborne acoustical noise emissions	36 dB(A) re 1 pW
Classe de eficiência energética	E	Autonomia de conservação sem energia elétrica	9.50 h
Classe de emissão de ruído acústico aerotransportado	C	4 estrelas - Capacidade de congelamento	2.6 Kg/24h
Volume líquido total	110 l	Classe climática	SN, N, ST
Soma dos volumes do(s) compartimento(s) congelado(s)	14 l	EEl	100 %

Soma dos volumes do(s) 110 l
compartimento(s)
refrigerado(s) e do(s)
compartimento(s) não
congelado(s)





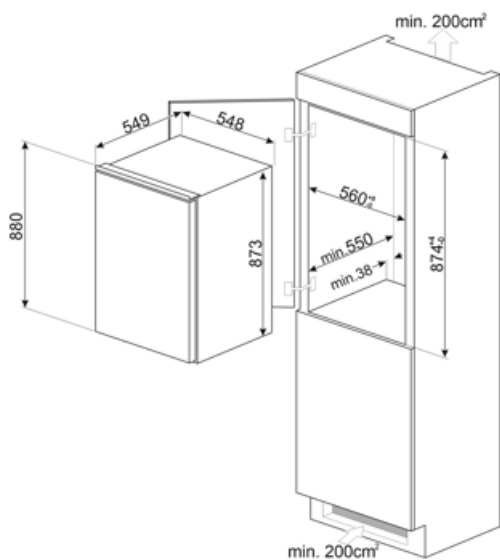

Electrical Connection

Plug (F;E) Schuko
Electrical connection 100 W
rating
Current 0,6 A

Voltage (V) 230-240 V
Frequency (Hz) 50 Hz
Power supply cable
length 240 cm



Symbols glossary

- | | | | |
|--|--|---|--|
|  | Compartimento de congelamento de 4 estrelas para uma melhor preservação dos alimentos. |  | O sistema de descongelamento automático funciona descongelando automaticamente em intervalos regulares, eliminando a necessidade de descongelar completamente. |
|  | E: Classificação energética do produto |  | Iluminação interior LED: é uma forma mais eficiente em termos energéticos e duradoura de iluminar o interior do aparelho. |
|  | Nicho incorporado |  | Classe de eficiência energética E. |

Benefit (TT)

Refrigerant gas R600a

Environmentally friendly R600a refrigerant gas contributes to rapid cooling with lower energy consumption

Climate class

Climatic class SN-T makes the appliance suitable for working at room temperature between 10 °C and 43 °C (50 °F ~ 109 °F)

Refrigerator Internal lighting

Interior lighting for perfect visibility of shelves in the refrigerator compartment

Fruit and vegetable drawer

The fruit and vegetable drawer ensures the best storage conditions for fresh food, avoiding any contamination