

## S4C122E

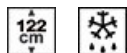

Product familie	Koelkast
Installatie	Inbouw
Categorie	Enkeldeurs koelkast
Inbouwnis	122
Referentie breedte	Tot 60 cm cm
Referentie hoogte	100 - 160 cm cm
Type koelen	Statisch
Ontdooien	Automatisch ontdooien koelkast, manueel vriezer
Type scharnier	Bevestiging met geleiders
Positie scharnier	Rechts
Deur omkeerbaar	Ja
EAN-code	8017709337124



## Design

Design	Universeel	Kleur zijkanten	Wit
Kleur	Wit	Logo	Geëtst
Materiaal deur	Plaatstaal	Kleur profielen binnenzijde	Wit
Materiaal zijwanden	Staal	Kleur profiel glazen leggers	Wit

## Uitrusting koelkast



Number of compartments	1	Afdekplaat groentenlade	Ja
Compartment types	Fruit and vegetable compartment	Type afdekplaat groente-/fruitlade	Glas
Aantal verstelbare leggers	3	Aantal lampen	1
Aantal groente-/fruitlades	1	Binnenverlichting koelkast	Ja
Shelves material	Glas	Type binnenverlichting koelkast	LED
Type afdekplaat groente-/fruitlade	Standaard		

## Binnendeur koelkast

Aantal binnendeurcompartimenten met transparante deksel	1	Aantal flessenhouders	1
---	---	-----------------------	---

Aantal verstelbare  
binnendeurcompartimenten 2

## Overige features koelkast

Humidity Control No Accessoires Eierhouder

## Uitrusting vriezer

Vriesvak Ja

## Overige technische eigenschappen

Type temperatuurcontrole Elektro-mechanisch  
Aantal compressoren 1  
Type koelgas R600a  
Type compressor Standaard  
Hoeveelheid koelmiddel 38 g  
Schuimmiddel Cyclopentaan

## Prestaties/Energie label - Reg. 2019

 Annual energy consumption 146 kWh/jaar  
Energie-efficiëntieklasse E  
Emissieklasse voor akoestisch luchtgeluid B  
Totaal netto volume 188 l  
Netto inhoud vriesgedeelte 14 l  
Netto inhoud koelgedeeltes 174 l  
Geluidsniveau 35 dB(A) re 1 pW  
Conserveringsduur zonder stroom 8,00 h  
4 star - Freezing capacity 2,7 kg/24h  
Klimaatklasse SN, N, ST, T  
EEI 100 %

## Elektrische aansluiting

Nominale aansluitwaarde 130 W  
Stroom (A) 1 A  
Spanning (V) 230-240 V  
Frequentie (Hz) 50 Hz  
Lengte stroomkabel 240 cm  
Stekker (F;E) Schuko

## Logistieke informatie

Breedte product (mm) 548 mm  
Width of the built-in niche 560 mm  
Maximum hoogte 1218 mm  
Height of the built-in niche 1225 mm

Diepte zonder handvat 549 mm  
en spacer

Depth of the built-in  
niche 550 mm



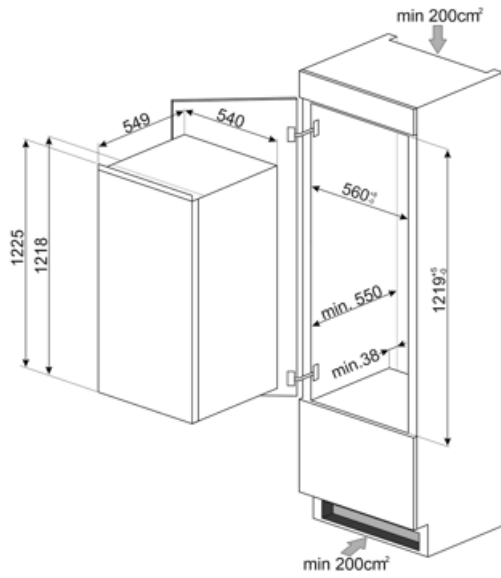

Product breedte met  
maximale deuropening 548 mm



---

## Symbols glossary

---

- |  |   |   |   |
|--|---|---|---|
|  | 4 stars freezing compartment for better food preservation.  |  | The automatic defrost system works by automatically defrosting at regular intervals eliminating the need to defrost altogether. |
|  | LED interior lighting: is a more energy efficient and long lasting way of illuminating the interior of the appliance. |  | Built-in niche  |
|  | Energie-efficiëntieklasse   |   |   |