

## S4C122F



Product familie	Koelkast
Installatie	Inbouw
Categorie	Enkeldeurs koelkast
Inbouwnis	122
Referentie breedte	Tot 60 cm cm
Referentie hoogte	100 - 160 cm cm
Type koelen	Statisch
Ontdooien	Automatisch ontdooien koelkast, manueel vriezer
Type scharnier	Bevestiging met geleiders
Positie scharnier	Rechts
Deur omkeerbaar	Ja
EAN-code	8017709295431



## Design



Design	Universeel	Logo	Geëtst
Kleur	Wit	Kleur profielen binnenzijde	Wit
Materiaal deur	Plaatstaal	Kleur profiel glazen leggers	Wit
Materiaal zijwanden	Staal	Display	Touch LCD
Kleur zijkanten	Wit	Positie display	Interno (cella frigo)

## Uitrusting koelkast



Aantal verstelbare leggers	3	Afdekplaat groentenlade	Ja
Aantal groente-/fruitlades	1	Type afdekplaat groente-/fruitlade	Glas
Shelves material	Glas	Binnenverlichting koelkast	Ja
Type afdekplaat groente-/fruitlade	Standaard	Type binnenverlichting koelkast	LED

## Binnendeur koelkast

Aantal binnendeurcompartimenten met transparante deksel	1	Aantal flessenhouders	1
---	---	-----------------------	---

Aantal verstelbare  
binnendeurcompartimenten 2

## Overige features koelkast

Accessoires Eierhouder

## Uitrusting vriezer

Vriesvak Ja

## Overige technische eigenschappen



Display functies	Snel-vriesfunctie, Cooling timer
Type temperatuurcontrole	Elektro-mechanisch
Aantal compressoren	1
Type koelgas	R600a
Type compressor	Standaard
Hoeveelheid koelmiddel	38 g
Schuimmiddel	Cyclopentaan

## Prestaties/Energie label - Reg. 2019



Annual energy consumption	182 kWh/jaar	Geluidsniveau	35 dB(A) re 1 pW
Energie-efficiëntieklasse	F	Conserveringsduur zonder stroom	8,00 h
Emissieklasse voor akoestisch luchtgeluid	B	4 star - Freezing capacity	2,7 kg/24h
Totaal netto volume	188 l	Klimaatklasse	SN, N, ST, T
Netto inhoud vriesgedeelte	14 l	EEL	125 %
Netto inhoud koelgedeeltes	174 l		

## Elektrische aansluiting

Nominale aansluitwaarde	130 W	Frequentie (Hz)	50 Hz
Stroom (A)	1 A	Lengte stroomkabel	240 cm
Spanning (V)	230-240 V	Stekker	(F;E) Schuko

## Logistieke informatie

Breedte product (mm)	548 mm	Maximum hoogte	1218 mm
----------------------	--------	----------------	---------

Width of the built-in niche 560 mm  
Diepte zonder handvat en spacer 549 mm  
Depth of the built-in niche 550 mm

Height of the built-in niche 1225 mm  
Product breedte met maximale deuropening 548 mm

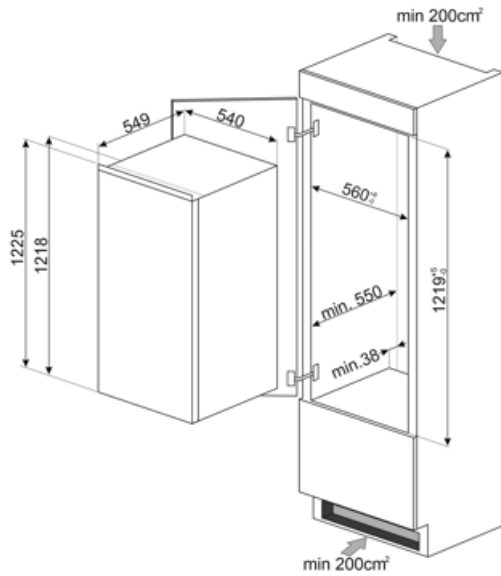

## Symbols glossary



4 stars freezing compartment for better food preservation.



The automatic defrost system works by automatically defrosting at regular intervals eliminating the need to defrost altogether.



A++: Energy efficiency class A++ helps to save up to 20% energy compared to class A. Maximum performance with minimum consumption is guaranteed.



LCD display: to optimize performance and simplify the use of the appliance.



Fast freezing: The fast freezing function brings the temperature of the compartment down when activated a few hours prior to usage.



LED interior lighting: is a more energy efficient and long lasting way of illuminating the interior of the appliance.



Built-in niche



Energie-efficiëntieklasse