

S4C122F

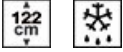

Product Family	Refrigerator
Installation	Built-in
Category	One Door
Built-in niche	122
Reference width	Until 60
Reference height	100 - 160
Cooling type	Static
Defrost	Automatic for refrigerator, manual for freezer
Hinge type	Sliding
Hinge position	Right
Reversible door	Yes
EAN code	8017709295431



Aesthetics



Aesthetic	Universal	Cor do perfil da prateleira de vidro	White
Colour	White	Display	LCD Touch
Material	Metal sheet	Mostrar porções	Interno (cela frigo)
Side material	Steel	Dispenser	No
Side colour	White	Water Filter	No
Logotipo	Logotipo serigrafado	HomeBar	No
Cor do perfil das prateleiras da porta	White		

Refrigerator compartment features



No. of adjustable shelves	3	Type of crisper/vegetable drawers cover	Glass
Number of fruit and vegetables drawers	1	Life Plus zone-0°C	No
Type of adjustable shelves	Glass	Compartimento baixa temperatura	No
Type of crisper/vegetable drawers cover	Standard	Internal light in fridge	Yes
Crisper Cover	Yes	Type of internal light (fridge)	LED
Bottle shelf	No		

Refrigerator Inner Door

No. of door shelves with transparent cover	1	No. of bottle shelves	1
Number of adjustable door shelves	2	Bottle shelves with wire support	No
Adjustable door shelves with wire support	No		

Other Refrigerator features

Accessories	Egg tray	Fan	No
Natural Plus Blu Light	No	Ionizer	No
MultiFlow	No		

Freezer compartment features

Internal freezer compartment	Yes	Internal light in freezer	No
------------------------------	-----	---------------------------	----

Other technical features



Functions display	Fast freezing, Cooling timer
Power on lamp	No
Temperature alarm lamp	No
Door open alarm	No
Temperature Alarm	No
Type of temperature control	Electro-mechanical
No. of compressors	1
Refrigerant gas type	R600a
Type of compressor	Standard
Refrigerant Quantity (gr)	38 g
Espuma expansiva de isolamento	Ciclopentano

Etiqueta de Desempenho / Energia - Reg. 2019



Consumo de energia anual	182 kWh/a	Airborne acoustical noise emissions	35 dB(A) re 1 pW
Classe de eficiência energética	F	Autonomia de conservação sem energia elétrica	8.00 h
Classe de emissão de ruído acústico aerotransportado	B	4 estrelas - Capacidade de congelamento	2.7 Kg/24h
Volume líquido total	188 l	Classe climática	SN, N, ST, T
Soma dos volumes do(s) compartimento(s) congelado(s)	14 l	EEl	125 %







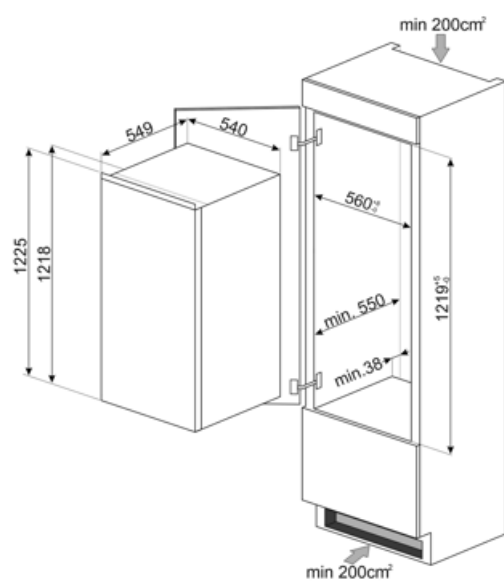

Soma dos volumes do(s) 174 l
compartimento(s)
refrigerado(s) e do(s)
compartimento(s) não
congelado(s)

Electrical Connection

Plug	(F;E) Schuko	Voltage (V)	230-240 V
Electrical connection rating	130 W	Frequency (Hz)	50 Hz
Current	1 A	Power supply cable length	240 cm



Symbols glossary

- | | | | |
|--|--|---|--|
|  | Compartimento de congelamento de 4 estrelas para uma melhor preservação dos alimentos. |  | O sistema de descongelamento automático funciona descongelando automaticamente em intervalos regulares, eliminando a necessidade de descongelar completamente. |
|  | A++: A classe de eficiência energética A++ ajuda a economizar até 20% de energia em comparação com a classe A. O desempenho máximo com consumo mínimo é garantido. |  | Classe de eficiência energética F |
|  | Display LCD: para otimizar o desempenho e simplificar o uso do aparelho. |  | CONGELAMENTO RÁPIDO: A função de congelamento rápido reduz a temperatura do compartimento quando ativado algumas horas antes do uso. |
|  | Iluminação interior LED: é uma forma mais eficiente em termos energéticos e duradoura de iluminar o interior do aparelho. |  | Nicho incorporado |

Benefit (TT)

Refrigerant gas R600a

Environmentally friendly R600a refrigerant gas contributes to rapid cooling with lower energy consumption

Climate class

Climatic class SN-T makes the appliance suitable for working at room temperature between 10 °C and 43 °C (50 °F ~ 109 °F)

Refrigerator Internal lighting

Interior lighting for perfect visibility of shelves in the refrigerator compartment

Fruit and vegetable drawer

The fruit and vegetable drawer ensures the best storage conditions for fresh food, avoiding any contamination

Internal display

Internal display for targeted temperature control and a clean, minimalist design