

S4L100F

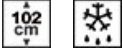

Product Family	Refrigerator
Installation	Built-in
Category	One Door
Built-in niche	102
Reference width	Until 60
Reference height	100 - 160
Sistema Total No - Frost	No
Cooling type	Static
Defrost	Automatic
Hinge type	Sliding
Hinge position	Right
Reversible door	Yes
EAN code	8017709292331



Aesthetics

Aesthetic	Universal	Side colour	White
Colour	White	Logotipo	Logotipo serigrafado
Design	Flat	Cor do perfil das prateleiras da porta	White
Material	Metal sheet	Cor do perfil da prateleira de vidro	White
Handle kit to be ordered separately	No	Display	No
Handle type	Fixed	Dispenser	No
Logo colour	Black	Water Filter	No
Side material	Steel	HomeBar	No

Refrigerator compartment features



No. of adjustable shelves	3	Type of crisper/vegetable drawers cover	Glass
Number of fruit and vegetables drawers	1	Life Plus zone-0°C	No
Type of adjustable shelves	Glass	Compartimento baixa temperatura	No
Type of crisper/vegetable drawers cover	Standard	Internal light in fridge	Yes
Crisper Cover	Yes	Type of internal light (fridge)	LED
Bottle shelf	No		

Refrigerator Inner Door

No. of door shelves with transparent cover	1	No. of bottle shelves	1
Number of adjustable door shelves	2	Bottle shelves with wire support	No
Adjustable door shelves with wire support	No		

Other Refrigerator features

Accessories	Egg tray	Fan	No
Natural Plus Blu Light	No	Ionizer	No
MultiFlow	No		

Freezer compartment features

Internal freezer compartment	No	Internal light in freezer	No
------------------------------	----	---------------------------	----

Other technical features

Power on lamp	No
Temperature alarm lamp	No
Door open alarm	No
Temperature Alarm	No
Type of temperature control	Electro-mechanical
No. of compressors	1
Refrigerant gas type	R600a
Type of compressor	Standard
Refrigerant Quantity (gr)	20 g
Espuma expansiva de isolamento	Ciclopentano

Etiqueta de Desempenho / Energia - Reg. 2019



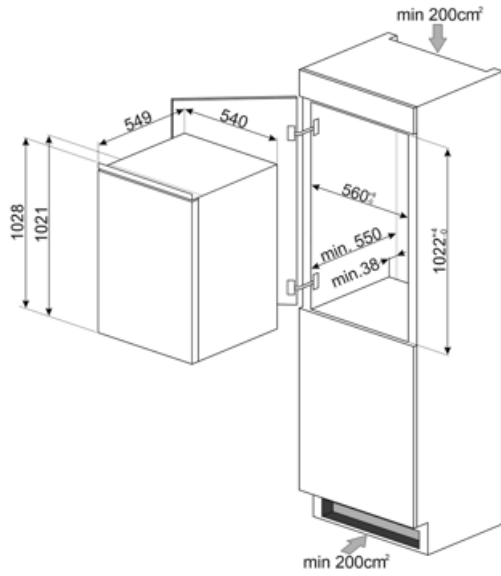

			
Consumo de energia anual	123 kWh/a	Airborne acoustical noise emissions	35 dB(A) re 1 pW
Classe de eficiência energética	F	Autonomia de conservação sem energia elétrica	0.00 h
Classe de emissão de ruído acústico aerotransportado	B	Classe climática	SN, N, ST
Volume líquido total	182 l	EI	125 %
Soma dos volumes do(s) compartimento(s) refrigerado(s) e do(s) compartimento(s) não congelado(s)	182 l		

Electrical Connection

Plug	(F;E) Schuko	Voltage (V)	230-240 V
Electrical connection rating	70 W	Frequency (Hz)	50 Hz
Current	0,4 A	Power supply cable length	240 cm



Symbols glossary

-  A++: A classe de eficiência energética A++ ajuda a economizar até 20% de energia em comparação com a classe A. O desempenho máximo com consumo mínimo é garantido.
-  Iluminação interior LED: é uma forma mais eficiente em termos energéticos e duradoura de iluminar o interior do aparelho.
-  Classe de eficiência energética F
-  O sistema de descongelamento automático funciona descongelando automaticamente em intervalos regulares, eliminando a necessidade de descongelar completamente.
-  Nicho incorporado

Benefit (TT)

Refrigerant gas R600a

Environmentally friendly R600a refrigerant gas contributes to rapid cooling with lower energy consumption

Climate class

Climatic class SN-T makes the appliance suitable for working at room temperature between 10 °C and 43 °C (50 °F ~ 109 °F)

Refrigerator Internal lighting

Interior lighting for perfect visibility of shelves in the refrigerator compartment

Fruit and vegetable drawer

The fruit and vegetable drawer ensures the best storage conditions for fresh food, avoiding any contamination